

***TB 9-6625-2340-24**

DEPARTMENT OF THE ARMY TECHNICAL BULLETIN

CALIBRATION PROCEDURE FOR SPECTRUM ANALYZER HEWLETT-PACKARD, MODEL 8566B

Headquarters, Department of the Army, Washington, DC
18 December 2008

Distribution Statement A: Approved for public release; distribution is unlimited.

REPORTING OF ERRORS AND RECOMMENDING IMPROVEMENTS

You can improve this manual. If you find any mistakes or if you know of a way to improve these procedures, please let us know. Mail your letter or DA Form 2028 (Recommended Changes to Publications and Blank Forms) directly to: Commander, U.S. Army Aviation and Missile Command, ATTN: AMSAM-MMC-MA-NP, Redstone Arsenal, AL 35898-5000. A reply will be furnished to you. You may also send in your comments electronically to our E-mail address: 2028@redstone.army.mil or by fax 256-842-6546/DSN 788-6546. For the World Wide Web use: <https://amcom2028.redstone.army.mil>. Instructions for sending an electronic 2028 can be found at the back of this manual.

SECTION		Paragraph	Page
	I. IDENTIFICATION AND DESCRIPTION		
	Test instrument identification	1	2
	Forms, records, and reports	2	2
	Calibration description	3	2
	II. EQUIPMENT REQUIREMENTS		
	Equipment required	4	4
	Accessories required	5	4
	III. CALIBRATION PROCESS		
	Preliminary instructions.....	6	5
	Equipment setup	7	6
	Frequency stability	8	6
	Calibrator amplitude	9	7
	Center frequency accuracy	10	8
	Frequency span accuracy.....	11	15

*This bulletin supersedes TB 9-6625-2340-35, dated 14 May 2003, including all changes.

	Paragraph	Page
Bandwidth accuracy and selectivity.....	12	16
Bandwidth switching	13	22
Log scale switching	14	33
IF gain uncertainty.....	15	36
Scale fidelity	16	45
Frequency response	17	48
Sweep time accuracy	18	52
Line related sidebands	19	54
Average noise level.....	20	55
Residual response	21	56
Harmonic distortion	22	59
Out of band response.....	23	64
Gain compression.....	24	72
First LO output amplitude accuracy	25	77
Sweep + tune out accuracy.....	26	77
Fast sweep time accuracy	27	78
Power supply.....	28	79
Final procedure.....	29	82

**SECTION I
IDENTIFICATION AND DESCRIPTION**

1. Test Instrument Identification. This bulletin provides instructions for the calibration of Spectrum Analyzer, Hewlett-Packard, Model 8566B. The manufacturer's manual was used as the prime data source in compiling these instructions. The equipment being calibrated will be referred to as the TI (test instrument) throughout this bulletin.

a. Model Variations. None that affect calibration.

b. Time and Technique. The time required for this calibration is approximately 16 hours, using the dc and low frequency and microwave technique.

2. Forms, Records, and Reports

a. Forms, records, and reports required for calibration personnel at all levels are prescribed by TB 750-25.

b. Adjustments to be reported are designated (R) at the end of the sentence in which they appear. When adjustments are in tables, the (R) follows the designated adjustment. Report only those adjustments made and designated with (R)

3. Calibration Description. TI parameters and performance specifications which pertain to this calibration are listed in table 1.

Table 1. Calibration Description

Test instrument parameters	Performance specifications
Frequency reference oscillator stability	<1 X 10 ⁻⁹ per day
Calibrator amplitude	Range: -10 dBm at 100 MHz Accuracy: ± 0.3 dB
Center frequency readout	Range: 0 Hz to 18 GHz Accuracy: For spans >5 MHz: ±(2% of freq spans + n x 100 kHz + freq reference error x center freq); n = harmonic mixing number. For spans ±5 MHz:: ±(2% of freq span + freq ref error x center freq + 10 Hz)
Frequency span	Range: 100 Hz – 10 GHz Accuracy: Spans ±5 MHz: ± 1% of indicated separation; >5 MHz: ± 3% of indicated separation.
Resolution bandwidth	Range: 3 dB bandwidths of 10 Hz to 3 MHz Accuracy: 10 Hz to 3 MHz: ± 20% 3 kHz to 1 MHz: ±10% 60 dB: 3dB bandwidth ratio
Selectivity	<15 1, 100 kHz to 3 MHz <13 1, 10 kHz to 30 kHz <11 1, 30 Hz to 3 kHz , 10 Hz bandwidth 60 dB points <100 Hz
Resolution bandwidth switching	Range: 10 Hz to 3 MHz Accuracy: Ref to 1 MHz 10 Hz: ±2.0 dB 30 Hz: ±0.8 dB 100 Hz to 1 MHz: ±0.5 dB, 3 MHz: ±1 dB
IF gain	Range: 0 to -129.9 dBm Accuracy: 0 to -70 dBm: ±0.6 dB, -70 to -130 dBm: ±1.0 dB
Scale fidelity	Range: 0 to 90 dB Accuracy: ±0.1 dB/dB over 0 to 80 dB display Cumulative: <±1 dB max over 0 to 80 dB display <±1.5 dB max over 0 to 90 dB display Lin: ±3% of reference level
Sweep time	Range: 20 ms to 200 sec Accuracy: ±200 sec; ±10%, >200 sec; ±30%
Frequency response	Range: 100 Hz to 18 GHz Accuracy: 100 Hz to 2.5 GHz: ±0.6 dB 2.5 GHz to 12.5 GHz: ±1.7 dB 12.5 GHz to 18 GHz: ±2.2 dB
Gain compression	<1.0 dB, 100 Hz to 18 GHz <-5 dBm at input mixer
Average noise level	<u>Non-preselected:</u> <u>Preselected:</u> <-95 dBm 100 Hz to 50 kHz <-132 dBm: 22.0 to 5.8 GHz <-112 dBm 50 kHz to 1 MHz □ <-125 dBm: 5.8 to 12.5 GHz <134 dBm 1 MHz to 2.5 GHz <-139 dBm: 12.5 to 18 GHz
Residual response	<-100 dBm: 100 Hz to 5.8 GHz <-95 dBm: 5.8 GHz to 12.5 GHz <-85 dBm: 12.5 GHz to 18 GHz

Table 1. Calibration Description - Continued

Test instrument parameters	Performance specifications
1 st Local oscillator output amplitude	>+5 dBm: 2.3 GHz to 6.1 GHz
Harmonic distortion	Second harmonic: Center frequency mixer input distortion: 100 Hz to 0.7 GHz: ≤-40 dBm ≤-80 dBc .07 to 2.5 GHz: ≤-40 dBm <-80 dBc 2.0 to 18 GHz: <-10 dBm <100 dBc
Intermodulation distortion	Third order intercept: >+5 dBm: 100 Hz to 5 MHz >+7 dBm: 5 MHz to 5.8 GHz > 5 dBm: 5.8 GHz to 18 GHz
Image and out of band response	<-70 dBc: 100 Hz to 18 GHz

SECTION II EQUIPMENT REQUIREMENTS

4. Equipment Required. Table 2 identifies the specific equipment to be used in this calibration procedure. This equipment is issued with Secondary Transfer Calibration Standards Sets AN/GSM-287, AN/GSM-705 or Secondary Reference Set NSN 4931-00-621-7878. Alternate items may be used by the calibrating activity. The items selected must be verified to perform satisfactorily prior to use and must bear evidence of current calibration. The equipment must meet or exceed the minimum use specifications listed in table 2. The accuracies listed in table 2 provide a four-to-one ratio between the standard and TI.

5. Accessories Required. The accessories required for this calibration are common usage accessories, issued as indicated in paragraph 4 above, and are not listed in this calibration procedure. The following peculiar accessory is also required for this calibration: 50 Ω, 20 W dummy load.

Table 2. Minimum Specifications of Equipment Required

Common name	Minimum use specifications	Manufacturer and model (part number)
ATTENUATOR NO. 1	Range: 0 to 12 dB Frequency: 50 MHz	Hewlett-Packard, Model 355C (7910807)
ATTENUATOR NO 2	Range: 0 to 60 dB Frequency: 300 MHz	Hewlett-Packard, Model 355D (355D)
ELECTRONIC COUNTER	Range: 20 ms to 200 s Accuracy: ± 10%	Fluke, Model PM6681/656 (PM6681/656)
FUNCTION GENERATOR	Frequency range: 2 kHz to 100 kHz triangle wave @ 1 V amplitude	(SG-1288/G)
FUNCTION/ARBITRARY GENERATOR	Frequency range: 1 Hz to 100 kHz Sweep time: 1 sec to 99.9 sec	Agilent, Model 33250A (33250A)
LOW PASS FILTER ¹	fc 250 MHz	K&L Model 5L380-250-B/B (5L380-250-B/B)
LOW PASS FILTER ¹	fc 1200 MHz	Hewlett-Packard, Model 360B (360B)
LOW PASS FILTER ¹	fc 8 GHz	K&L Model 6L250-8000-NP/N (6L250-8000-NP/N)
MEASURING RECEIVER	Frequency range: 300 MHz Accuracy: ±300 Hz dBm range:-9.7 to -10.3 Accuracy: ±0.075 dBm	Measuring receiver system N5531S consisting of: Spectrum Analyzer Agilent, Model E4440A (E4440A), Power Meter Agilent, Model E4419B (E4419B), and Sensor Module Agilent, Model 518 (518)

See footnote at end of table.

Table 2. Minimum Specifications of Equipment Required - Continued

Common name	Minimum use specifications	Manufacturer and model (part number)
MICROWAVE FREQUENCY COUNTER	Frequency range: 2 GHz to 18 GHz Accuracy: 1 kHz ± 1 count	Anritsu, Model MF2414B (MF2414B)
MULTIMETER	Range: 1000 Vdc Accuracy: ±2 Vdc	Fluke, Model 8840A/AF05 (AN/GSM 64D)
OSCILLOSCOPE	Range: Vert. 2 Volts / cm Horiz. 100 ms / cm	(OS-303/G)
POWER SPLITTER	Range: 20 MHz to 18 GHz	Weinschel, Model 1870A (7916839)
SIGNAL GENERATOR	Frequency range: 100 kHz to 2 GHz Power range: 0 to -15 dBm Accuracy: ±2 dBm	Aeroflex, Model 2023B (2023B) or (SG-1207/U)
SYNTHESIZED SIGNAL GENERATOR NO. 1	Frequency range: 2 GHz to 18 GHz Power range: 0 to -120 dBm Accuracy: ±1.525 dBm	Anritsu, Model 68369NV (68369NV)
SYNTHESIZED SIGNAL GENERATOR NO. 2	Frequency range: 2 GHz to 18 GHz Power range: 0 to -120 dBm Accuracy: ±1.525 dBm	Anritsu, Model 68369NV (68369NV)
SYNTHESIZER/LEVEL GENERATOR	Frequency range: 10 kHz to 50 MHz Amplitude range: -80 to +10 dBm Accuracy: ±0.02 dB per 10 dB step	Hewlett-Packard, Model 3335AOPT001-KO6 (MIS-35938)
TIME/FREQUENCY WORKSTATION	Resolution: 1 x 10 ⁻¹⁰	Datum, Model ET6000-75 (13589305)

¹Limited deploy.

SECTION III CALIBRATION PROCESS

6. Preliminary Instructions

a. The instructions outlined in paragraphs 6 and 7 are preparatory to the calibration process. Personnel should become familiar with the entire bulletin before beginning the calibration.

b. Items of equipment used in this procedure are referenced within the text by common name as listed in table 2.

c. Unless otherwise specified, verify the result of each test and, whenever the test requirement is not met, take corrective action before continuing with the calibration. Additional maintenance information is contained in the manufacturer's manual.

d. When indications specified in paragraphs 8 through 27 are not within tolerance, perform the power supply check prior to making adjustments. After adjustments are made, repeat paragraphs 8 through 27. Do not perform power supply check if all other parameters are within tolerance.

e. Unless otherwise specified, all controls and control settings refer to TI.

7. Equipment Setup

WARNING

HIGH VOLTAGE is used or exposed during the performance of this calibration. DEATH ON CONTACT may result if personnel fail to observe safety precautions. REDUCE OUTPUT(S) to minimum after each step within the performance check where applicable.

CAUTION

Before connecting TI to power source, make sure TI is set to the power source line voltage as shown on rear of TI.

a. Connect TI to 115 V ac power source.

b. Press TI **POWER** switch to **ON** and allow at least 30 minutes for TI to warm-up and stabilize.

8. Frequency Stability

a. Performance Check

(1) Position TI on its right side.

(2) Remove cable between **FREQ REFERENCE INT** and **EXT** connectors.

(3) Set rear panel **FREQ REFERENCE** switch to **INT**.

(4) Connect TI **FREQ REFERENCE INT** to time/frequency workstation **TIME / FREQUENCY INPUT**.

(5) Remove TI bottom cover.

NOTE

The TI must be warmed up for at least 48 hours before this test is performed.

(6) Remove A22 adjustment cover screws.

(7) Adjust A22 (fig. 1) for a minimum indication on the time/frequency workstation.

(8) Check the drift after 24 hours. The drift will be $<1 \times 10^{-9}$.

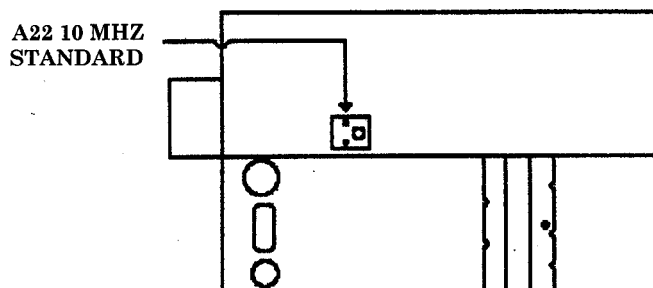

BOTTOM VIEW

Figure 1. Frequency adjust.

- (9) Replace screws over A22 adjust.
- (10) Replace TI bottom cover.
- (11) Reconnect cable between **FREQ REFERENCE INT** and **EXT** connectors.

b. Adjustments. No further adjustments can be made.

9. Calibrator Amplitude

a. Performance Check

- (1) Connect measuring receiver sensor module to measuring receiver power reference output.
- (2) Zero and calibrate the sensor module.
- (3) Disconnect sensor module from measuring receiver power reference output.
- (4) Connect measuring receiver sensor module to **TI CAL OUTPUT**.
- (5) Set up measuring receiver to measure power at 100 MHz. If displayed power measurement is not within the limits specified in table 3, perform **b** below.

Table 3. Calibrator Amplitude

Test instrument	Measuring receiver indications (dBm)	
	Min	Max
Cal output	-10.3	-9.7

b. Adjustments

- (1) Set **LINE** switch to **STANDBY**.
- (2) Position TI on its right side.
- (3) Remove TI bottom cover.
- (4) Set **LINE** switch to **ON**.
- (5) Adjust A6A9A1R11 CAL AMP. (fig. 2) for a measuring receiver indication of -10 ± 0.01 dBm (R).

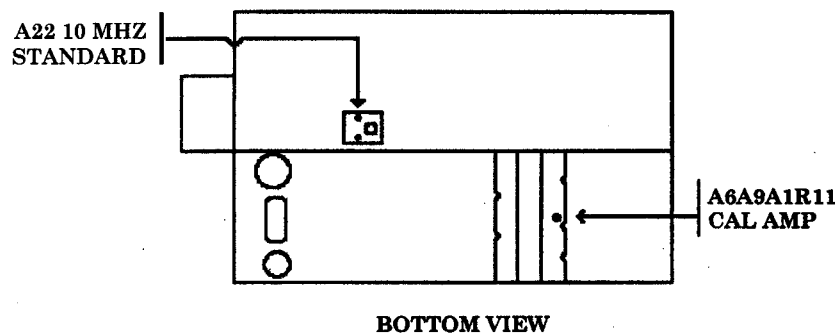

Figure 2. Calibrator amplitude adjustment.

- (6) Set **LINE** switch to **STANDBY**.
- (7) Replace TI bottom cover.
- (8) Set **LINE** switch to **ON**.

10. Center Frequency Accuracy

a. Performance Check

- (1) Connect TI **CAL OUTPUT** to TI **RF INPUT**.
- (2) Press **2 – 22 GHz, RECALL, 9** keys.
- (3) Adjust **FREQ ZERO** control for a maximum amplitude trace.
- (4) Press **2 – 22 GHz** key.
- (5) Disconnect TI **CAL OUTPUT** from TI **RF INPUT**.
- (6) Connect TI **RF INPUT** to synthesized signal generator No. 1 **RF Output**.
- (7) Connect TI **10 MHz OUT** (rear panel) to the synthesized signal generator No. 1 **10 MHz REF IN** (rear panel).
- (8) Set synthesized signal generator No. 1 for an output of 2.000000 GHz at a level of 0 dBm.
- (9) Press TI keys as listed in (a) through (d) below:
 - (a) **CENTER FREQUENCY, 2, GHz.**
 - (b) **FREQUENCY SPAN, 1, MHz.**
 - (c) **MARKER PEAK SEARCH.**
 - (d) **MKR → CF.**
- (10) Press TI **REFERENCE LEVEL** and adjust as necessary to place signal peak at convenient level.
- (11) If TI center frequency readout does not fall within limits listed in the first row of table 4, perform **b** below.
- (12) Repeat technique of (8) through (10) above for remaining center frequencies and frequency spans listed in table 4. If TI center frequency readout does not indicate within limits specified in table 4, perform **b** below.

Table 4. Center Frequency Accuracy

Synthesized signal generator	Test instrument			
	Center frequency (GHz)	Frequency span	Frequency readout	
			Min (GHz)	Max (GHz)
2	2	1 MHz	1.99998	2.00002
2	2	10 MHz	1.9997	2.0003
2	2	100 MHz	1.998	2.002
2	2	1 GHz	1.98	2.02
3	3	1 MHz	2.99998	3.00002
3	3	10 MHz	2.9997	3.0003
3	3	100 MHz	2.998	3.002
3	3	1 GHz	2.98	3.02
6	6	1 MHz	5.99998	6.00002

Table 4. Center Frequency Accuracy - Continued

Synthesized signal generator	Test instrument				
	Output frequency (GHz)	Center frequency (GHz)	Frequency span	Frequency readout	
				Min (GHz)	Max (GHz)
6	6	10 MHz	5.9997	6.0003	
6	6	100 MHz	5.998	6.002	
6	6	1 GHz	5.98	6.02	
9	9	1 MHz	8.99998	9.00002	
9	9	10 MHz	8.9997	9.0003	
9	9	100 MHz	8.998	9.002	
9	9	1 GHz	8.98	9.02	
9	9	10 GHz	8.8	9.2	
12	12	1 MHz	11.99998	12.00002	
12	12	10 MHz	11.9997	12.0003	
12	12	100 MHz	11.998	12.002	
12	12	1 GHz	11.98	12.02	
12	12	10 GHz	11.8	12.2	
15	15	1 MHz	14.99998	15.00002	
15	15	10 MHz	14.9997	15.0003	
15	15	100 MHz	14.998	15.002	
15	15	1 GHz	14.98	15.02	
15	15	10 GHz	14.8	15.2	
18	18	1 MHz	17.99998	18.00002	
18	18	10 MHz	17.9997	18.0003	
18	18	100 MHz	17.998	18.002	
18	18	1 GHz	17.98	18.02	
18	18	10 GHz	17.8	18.2	

(13) Disconnect TI **10 MHz OUT** (rear panel) from synthesized signal generator No. 1 **10 MHz REF IN** (rear panel).

b. Adjustments

- (1) Disconnect TI **RF INPUT** from synthesized signal generator No. 1 **RF Output**.
- (2) Set TI **LINE** switch to **STANDBY**.
- (3) Position TI on its right side.
- (4) Remove TI bottom cover.
- (5) Remove cover over A12 through A16 pc boards.
- (6) Jumper A12TP2 to A12TP3 (lock indicator disable).
- (7) Set TI **LINE** switch to **ON**.
- (8) Press **0 – 2.5 GHz, SWEEP TIME, 500, mS**.
- (9) Connect oscilloscope **Vertical 1** input to TI A16TP3 (fig. 3).
- (10) Connect TI **SWEEP + TUNE OUT** (rear panel) to oscilloscope **Vertical 2** input.

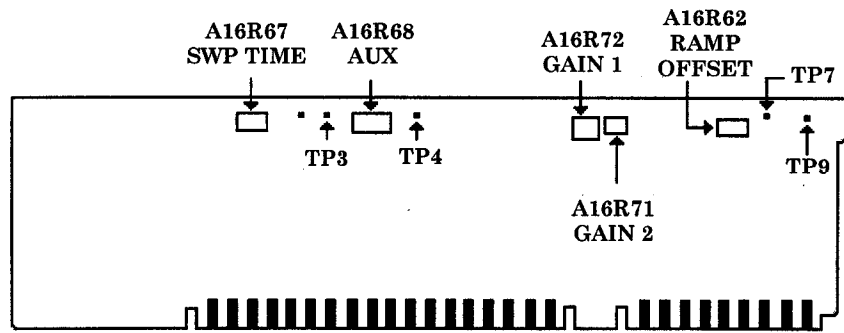

Figure 3. A16 board.

- (11) Set oscilloscope to display a 0 to 10 volt sweep ramp using **Vertical 2** as the trigger source.
- (12) Adjust A16R67 SWP TIME for a ramp of 500 msec (fig. 4) duration (R).
- (13) Disconnect oscilloscope from A16TP3 (fig. 3).
- (14) Connect oscilloscope to A16TP4 (fig. 3). Display should be similar to figure 4.

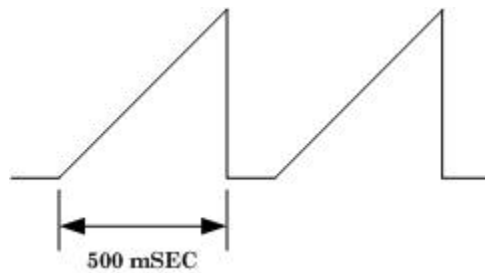

Figure 4. 500 mSec ramp.

- (15) Adjust A16R68 AUX (fig. 3) to align the dc level of the rest time between each ramp with the upper dc level of each ramp. Refer to RAMP 2 (fig. 5).

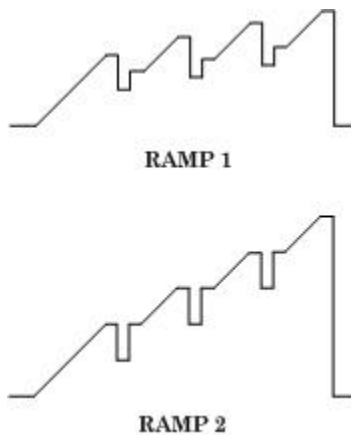

Figure 5. Ramps.

- (16) Disconnect oscilloscope from A16TP4 (fig. 3).

- (17) Connect multimeter **HI** to A16TP9 and **LO** to A16TP7 (fig. 3).
- (18) Press TI **SWEEP SINGLE** key.
- (19) Adjust A16R62 RAMP OFFSET (fig. 3) for a multimeter indication as close to 0.000 V dc as possible.
- (20) Repeat steps (18) and (19) until requirement is met.
- (21) Press TI keys as listed in (a) through (g) below:
- (a) **SWEEP SINGLE**.
 - (b) **START FREQ, 2.5, GHz**.
 - (c) **STOP FREQUENCY, 4.9, GHz**.
 - (d) **SHIFT, MKR→REF LVL**.
 - (e) **SAVE, 1**.
 - (f) **STOP FREQ, 2.51, GHz**.
 - (g) **SAVE, 2**.
- (22) Connect multimeter **HI** to A19TP2 and **LO** to A19TP3 (fig. 6).

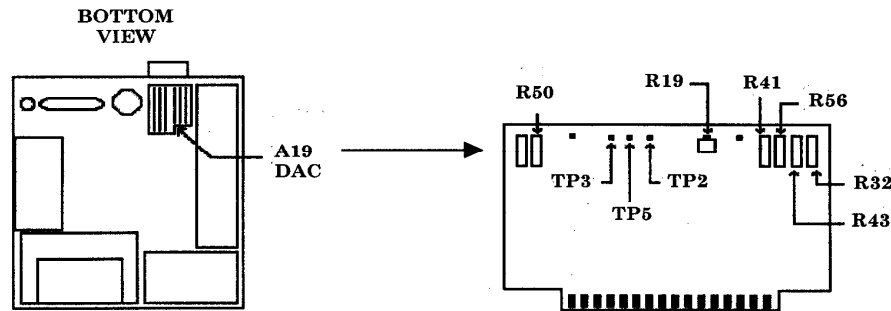

Figure 6. A19 board.

- (23) Press TI **RECALL, 1**.
- (24) Press TI **RECALL, 2**.
- (25) Repeat (23) and (24) above while monitoring multimeter.
- (26) The difference in multimeter indications for **RECALL, 1** and **RECALL, 2** should be < 1 mV dc. Multimeter indications will be approximately -8 V dc.
- (27) If necessary, adjust A19R19 (fig. 6) while alternating between **RECALL, 1** and **RECALL, 2** so that the difference in multimeter indications is < 1 mV dc (R).
- (28) Press TI keys as listed in (a) and (b) below:
- (a) **STOP FREQ, 22, GHz**.
 - (b) **SAVE, 3**.
- (29) Press TI **RECALL, 1** keys.
- (30) Press TI **RECALL, 3** keys.
- (30) Repeat (29) and (30) above while monitoring multimeter.

(31) The difference in multimeter indications for **RECALL, 1** and **RECALL, 3** should be < 3 mV dc.

(32) If necessary, adjust A19R41 (fig. 6) while alternating between **RECALL, 1** and **RECALL, 3** so that the difference in multimeter indications is < 3 mV dc (R).

(33) Press TI keys as listed in (a) through (g) below:

- (a) **2-22 GHz.**
- (b) **STOP FREQ, 3, GHz.**
- (c) **SHIFT, SWEEP CONT.**
- (d) **CENTER FREQUENCY, 2.0125, GHz.**
- (e) **SHIFT, MKR→REF LVL.**
- (f) **SWEEP SINGLE.**
- (g) **SHIFT, CF STEP SIZE, 0, Hz.**

(34) Connect multimeter **HI** to A19TP5 (fig. 6).

(35) Adjust A19R50 (fig. 6) for $+10.000 \pm 0.001$ V dc (R).

(36) Connect multimeter **HI** to A19TP2 (fig. 6).

(37) Adjust A19R19 (fig. 6) for -6.000 ± 0.001 V dc (R).

(38) Press TI **SHIFT, CF STEP SIZE, 4095,** and **Hz** keys.

(39) Adjust A19R19 (fig. 6) for -18.600 ± 0.001 V dc (R).

(40) Press TI keys as listed in (a) through (f) below:

- (a) **2-22 GHz.**
- (b) **CENTER FREQUENCY, 3.4286, GHz.**
- (c) **FREQUENCY SPAN, 2.5, GHz.**
- (d) **SHIFT, MKR→REF LVL.**
- (e) **SWEEP SINGLE.**
- (f) **SAVE, 1.**

(41) Adjust A19R56 (fig. 6) for -7.500 ± 0.001 V dc (R).

(42) Press TI keys as listed in (a) and (b) below:

- (a) **2-22 GHz.**
- (b) **RECALL, 1.**

(43) Press TI **SWEEP SINGLE.**

(43) Adjust A19R32 (fig. 6) for -15.000 ± 0.001 V dc (R).

(44) Repeat (42) and (43) above until three consecutive indications are within ± 0.001 V dc of one another.

(45) Press TI keys as listed in (a) through (h) below:

- (a) **2-22 GHz.**
- (b) **STOP FREQ, 5, GHz.**
- (c) **SHIFT, SWEEP CONT.**
- (d) **CENTER FREQUENCY, 3.4286, GHz.**
- (e) **FREQUENCY SPAN, 3, GHz.**
- (f) **SHIFT, MKR→REF LVL.**
- (g) **SWEEP SINGLE.**

- (h) **SAVE, 2.**
- (46) Adjust A19R41 (fig. 6) for -6.750 ± 0.001 V dc (R).
- (47) Press TI keys as listed in (a) and (b) below:
- 2-22 GHz.**
 - RECALL, 2.**
- (48) Adjust A19R43 (fig. 6) for -15.750 ± 0.001 V dc (R).
- (49) Press TI keys as listed in (a) and (b) below:
- 2-22 GHz.**
 - SHIFT, RES BW.**
- (50) Disconnect multimeter from A19TP2 and A19TP3 (fig. 6).
- (51) Connect a jumper between A20TP5 and A21TP2 (fig. 7).
- (52) Connect microwave frequency counter **Input 1** to **TI 1ST LO OUTPUT** through attenuator No. 2.
- (53) Set attenuator No. 2 for 10 dB.
- (54) Remove 8 cable (gray) at A11J1 (fig. 7).
- (55) Press TI keys as listed in (a) through (e) below:
- CENTER FREQUENCY, 2.3, GHz.**
 - FREQUENCY SPAN, 0, Hz.**
 - SAVE, 1.**
 - CENTER FREQUENCY, 6.15, GHz.**
 - SAVE, 2.**

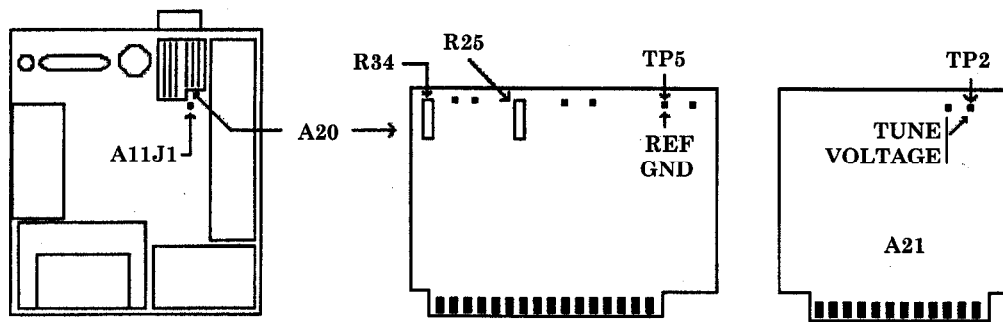

Figure 7. A20 board.

- (56) Press TI **RECALL, 1** and adjust A20R34 (fig. 7) for a microwave counter indication of $2300.0 \text{ MHz} \pm 0.1 \text{ MHz}$ (R).
- (57) Press TI **RECALL, 2** and adjust A20R25 (fig. 7) for a microwave counter indication of $6150.0 \text{ MHz} \pm 0.1 \text{ MHz}$ (R).
- (58) Repeat (56) and (57) above until requirements are met.
- (59) Disconnect microwave frequency counter from **TI 1ST LO OUTPUT**. Reconnect termination to **TI 1ST LO OUTPUT**.

- (60) Remove jumper from between A20TP5 and A21TP2 and reconnect 8 cable (gray) to A11J1 (fig. 7).
- (61) Press TI **2-22 GHz** key.
- (62) Connect TI **RF INPUT** to synthesized signal generator No. 1 **RF Output**.
- (63) Press TI keys as listed in (a) and (b) below:
 - (a) **CENTER FREQUENCY, 4, and GHz** keys.
 - (b) **FREQUENCY SPAN, 80, and MHz** keys.
- (64) Set synthesized signal generator No. 1 for an output frequency of 4 GHz at an output level of -10 dBm.
- (65) Press TI **MARKER PEAK SEARCH** key.
- (66) Alternately press TI **MARKER PEAK SEARCH** key and adjust A16R72GAIN1 (fig. 3) for a marker frequency indication of 4.00000 GHz on TI display.
- (67) Press TI keys as listed in (a) and (b) below:
 - (a) **FREQUENCY SPAN, 240, MHz.**
 - (b) **MARKER PEAK SEARCH.**
- (68) Alternately press TI **MARKER PEAK SEARCH** key and adjust A16R71GAIN2 (fig. 3) for a marker frequency indication of 4.00000 GHz on TI display.
- (69) Press TI keys as listed in (a) and (b) below:
 - (a) **2-22 GHz.**
 - (b) **CENTER FREQUENCY, 5.82, GHz.**
- (70) Change synthesized signal generator No. 1 output frequency to 5.82 GHz.
- (71) Adjust A19R43 (fig. 6) fully counterclockwise.
- (72) Press TI **FREQ STOP, 10, GHz** keys.
- (73) Adjust A19R43 (fig. 6) clockwise until the two signals displayed almost coincide (just barely discernable as separate signals).
- (74) Press TI **FREQ STOP, 12.5, GHz** keys.
- (75) Change synthesized signal generator No. 1 output frequency to 12.5 GHz.
- (76) Two almost coincident signals should be displayed. If not, slightly readjust A19R43 (fig. 6).
- (77) Change synthesized signal generator No. 1 output frequency to 5.8 GHz.
- (78) Press TI keys as listed in (a) and (b) below:
 - (a) **CENTER FREQUENCY, 5.8, GHz.**
 - (b) **FREQUENCY SPAN, 450, MHz.**
- (79) Adjust A19R32 (fig. 6) for best shaped single signal on TI display.
- (80) Press TI **2-22 GHz** key.
- (81) Remove jumper between A12TP2 and A12TP3.
- (82) Replace cover over A12 through A16 pc boards.
- (83) Replace TI bottom cover.

11. Frequency Span Accuracy

a. Performance Check

- (1) Press TI **2-22 GHz** key.
- (2) Connect TI **RF INPUT** to signal generator RF output connector.
- (3) Connect TI **10 MHz OUT** (rear panel) to signal generator external reference in connector (rear panel).
- (4) Set the signal generator for an output frequency of 40 MHz at a -10 dBm level.
- (5) Press TI keys as listed in (a) and (b) below:
 - (a) **CENTER FREQUENCY, 40, MHz.**
 - (b) **FREQUENCY SPAN, 20, kHz.**
- (6) Change signal generator output frequency to 39.992 MHz (table 5 low frequency).
- (7) Press TI **MARKER NORMAL, PEAK SEARCH.**
- (8) Press TI **MARKER Δ** and change signal generator output frequency to 40.008 MHz (table 5 high frequency).
- (9) Press TI **PEAK SEARCH.**
- (10) TI **MARKER Δ** frequency indication on TI display will indicate within limits specified in the first row of table 5.
- (11) Repeat technique of steps (5) (b) through (10) above for remaining signal generator frequencies and TI frequency spans listed in table 5. TI **MARKER Δ** frequency indications will indicate within limits specified in table 5.

Table 5. Narrow Span Accuracy

Signal generator		Test instrument		
Low frequency (MHz)	High frequency (MHz)	Frequency span	Indications (Δ)	
			Min	Max
39.980	40.020	50 kHz	39.60 kHz	40.40 kHz
39.940	40.060	150 kHz	118.80 kHz	121.20 kHz
39.920	40.080	200 kHz	158.4 kHz	161.6 kHz
39.600	40.400	1 MHz	792.00 kHz	808.00 kHz
39.200	40.800	2 MHz	1.584 MHz	1.616 MHz
37.600	42.400	6 MHz	4.656 MHz	4.944 MHz
36.000	44.000	10 MHz	7.76 MHz	8.240 MHz
20.000	60.000	50 MHz	38.80 Hz	41.20 MHz

- (12) Disconnect TI **RF INPUT** from signal generator RF output connector.
- (13) Connect TI **RF INPUT** to synthesized signal generator No. 1 **RF Output.**
- (14) Disconnect TI **10 MHz OUT** from signal generator external reference in connector (rear panel).
- (15) Connect TI **10 MHz OUT** (rear panel) to synthesized signal generator No. 1 **10 MHz REF IN** (rear panel).
- (16) Set the synthesized signal generator No. 1 for an output frequency of 4 GHz at a -10 dBm level.

- (17) Press TI keys as listed in (a) and (b) below:
 - (a) **CENTER FREQUENCY, 4, GHz.**
 - (b) **FREQUENCY SPAN, 500, MHz.**
- (18) Change synthesized signal generator No. 1 output frequency to 3.8 GHz (table 6 low frequency).
- (19) Press TI **MARKER NORMAL, PEAK SEARCH** key.
- (20) Press TI **MARKER Δ** and change synthesized signal generator No. 1 output frequency to 4.2 GHz (table 6 high frequency).
- (21) Press TI **MARKER PEAK SEARCH** key.
- (22) TI **MARKER Δ** frequency readout will read within limits specified in the first row of table 6.
- (23) Repeat technique of steps (17) through (22) above for remaining synthesized signal generator No. 1 frequencies and TI frequency spans listed in table 6. TI **MARKER Δ** frequency readout will read within limits specified in table 6.

Table 6. Wide Span Accuracy

Signal generator		Test instrument			
Low frequency (GHz)	High frequency (GHz)	Center frequency (GHz)	Frequency span	Readout (Δ)	Readout (Δ)
				Min	Max
3.800	4.200	4.0	500 MHz	388 MHz	412 MHz
9.800	10.200	10.0	500 MHz	388 MHz	412 MHz
14.800	15.200	15.0	500 MHz	388 MHz	412 MHz
17.600	18.000	17.8	500 MHz	388 MHz	412 MHz
3.600	4.400	4.0	1 GHz	776 MHz	824 MHz
9.600	10.400	10.0	1 GHz	776 MHz	824 MHz
14.600	15.400	15.0	1 GHz	776 MHz	824 MHz
17.200	18.000	17.6	1 GHz	776 MHz	824 MHz
8.000	12.000	10.0	5 GHz	3.88 GHz	4.12 GHz
13.000	17.000	15.0	5 GHz	3.88 GHz	4.12 GHz
14.000	18.000	16.0	5 GHz	3.88 GHz	4.12 GHz
6.000	14.000	10.0	10 GHz	7.76 GHz	8.24 GHz
10.000	18.000	14.0	10 GHz	7.76 GHz	8.24 GHz

b. Adjustments. No adjustments can be made.

12. Bandwidth Accuracy and Selectivity

a. Performance Check

- (1) Press TI **2-22 GHz** key.
- (2) Connect TI **CAL OUTPUT** to TI **RF INPUT**.
- (3) Press TI keys as listed in (a) through (f) below:
 - (a) **CENTER FREQUENCY, 100, MHz.**
 - (b) **FREQUENCY SPAN, 5, MHz.**
 - (c) **RES BW, 3, MHz.**
 - (d) **REFERENCE LEVEL, 10, -dBm.**
 - (e) **SCALE LIN, SHIFT, AUTO^A.**
 - (f) **REFERENCE LEVEL.**

(4) Adjust **DATA** knob to position trace at (or just below) reference level (top) graticule line.

(5) Press **TI SWEEP SINGLE** key.

(6) Press **TI MARKER NORMAL** key and adjust the **DATA** knob to place marker at the peak of the signal trace.

(7) Press **MARKER Δ** key and position moveable marker 3 dB down from the stationary marker on the positive slope of the signal trace (marker Δ indication on TI display should be -3.00 dBm).

(8) Press **MARKER Δ** key and position moveable marker 3 dB down from the stationary marker on the negative slope of the signal trace (marker Δ indication on TI display should be 0.00 dBm).

(9) If TI marker Δ frequency readout displayed is not within limits specified in first row of table 7, perform **b** below.

(10) Record TI displayed indication in actual indication column of table 7.

(11) Repeat technique of steps (3) through (8) and (11) above for remaining bandwidths and frequency spans listed in table 7. If TI marker Δ frequency readouts displayed are not within limits specified in table 7, perform **b** below.

Table 7. 3 dB Bandwidth Accuracy

Test instrument								
RES BW		FREQUENCY SPAN		Marker Δ readout @ 3 dB				
key		key		Min	Max	Actual indication		
3	MHz	5	MHz	2.400	MHz	3.600	MHz	
1	MHz	2	MHz	900	kHz	1.100	MHz	
300	kHz	500	kHz	270.0	kHz	330.0	kHz	
100	kHz	200	kHz	90.0	kHz	110.0	kHz	
30	kHz	50	kHz	27.00	kHz	33.00	kHz	
10	kHz	20	kHz	9.00	kHz	11.00	kHz	
3	kHz	5	kHz	2.700	kHz	3.300	kHz	
1	kHz	2	kHz	800	Hz	1.200	kHz	
300	Hz	500	Hz	240	Hz	360	Hz	
100	Hz	200	Hz	80	Hz	120	Hz	
30	Hz	100	Hz	24.0	Hz	36.0	Hz	
10	Hz	200	Hz	8.0	Hz	12.0	Hz	

(12) Press TI keys as listed in (a) through (g) below:

- (a) **2-22 GHz.**
- (b) **CENTER FREQUENCY, 100, MHz.**
- (c) **FREQUENCY SPAN, 25, MHz.**
- (d) **RES BW, 3, MHz.**
- (e) **VIDEO BW, 100, Hz.**
- (f) **SWEEP SINGLE.**
- (g) **MARKER NORMAL.**

(13) Position marker at peak of signal trace.

(14) Press **MARKER Δ** key and position moveable marker 60 dB down from the stationary marker on the positive slope of the signal trace.

(15) Press **MARKER Δ** key and position moveable marker 60 dB down from the stationary marker on the negative slope of the signal trace. Record displayed indication in Actual Indication column of table 8.

(16) Using the actual indication for 60 dB (table 8) at 3 MHz resolution bandwidth setting and the actual indication for 3 dB (table 7) at 3 MHz resolution bandwidth setting, calculate the bandwidth selectivity by using the formula below. If calculated ratio is not within limits specified in first row of table 8, perform **b** below.

$$60 \text{ dB reading} \div 3 \text{ db reading} = \text{ratio}$$

(17) Repeat the technique of (12) (d),(e), and (f) and (13) through (16) above for remaining **RES BW**, **FREQUENCY SPAN**, and **VIDEO BW** key settings listed in table 8. If calculated ratios are not within limits specified in table 8, perform **b** below.

Table 8. 60 dB Bandwidth Accuracy

Test instrument				Calculated ratio
RES BW key	FREQUENCY SPAN key	VIDEO BW key	Actual indication	
3 MHz	25 MHz	100 Hz		Max 15:1
1 MHz	15 MHz	300 Hz		15:1
300 kHz	5 MHz	AUTO		15:1
100 kHz	2 MHz	AUTO		15:1
30 kHz	500 kHz	AUTO		13:1
10 kHz	200 kHz	AUTO		13:1
3 kHz	50 kHz	AUTO		11:1
1 kHz	10 kHz	AUTO		11:1
300 Hz	5 kHz	AUTO		11:1
100 Hz	2 kHz	AUTO		11:1
30 Hz	500 Hz	AUTO		11:1
10 Hz	200 Hz	AUTO		60 dB points separated by <100 Hz

b. Adjustments

- (1) Remove top cover from TI.
- (2) Press TI keys as listed in (a) through (i) below:
 - (a) **2-22 GHz.**
 - (b) **CENTER FREQUENCY, 100, MHz.**
 - (c) **FREQUENCY SPAN, 5, MHz.**
 - (d) **RES BW, 3, MHz.**
 - (e) **REFERENCE LEVEL, 10, -dBm.**
 - (f) **SCALE LIN.**
 - (g) **SHIFT.**
 - (h) **AUTO^A.**
 - (i) **REFERENCE LEVEL.**

(3) Adjust **DATA** knob to position trace at (or just below) reference level (top) graticule line.

- (4) Press TI keys as listed in (a) through (d) below:
- MARKER NORMAL.**
 - MARKER PEAK SEARCH.**
 - MARKER→CF.**
 - MARKER Δ.**
- (5) Using TI **DATA** knob adjust marker down the positive going side of the displayed signal to the -3 dB point.
- (6) Adjust A4A9R60 (fig. 8) for a **MKR Δ** indication of 1.5 MHz while maintaining marker at the -3 dB point using TI **DATA** knob (R).

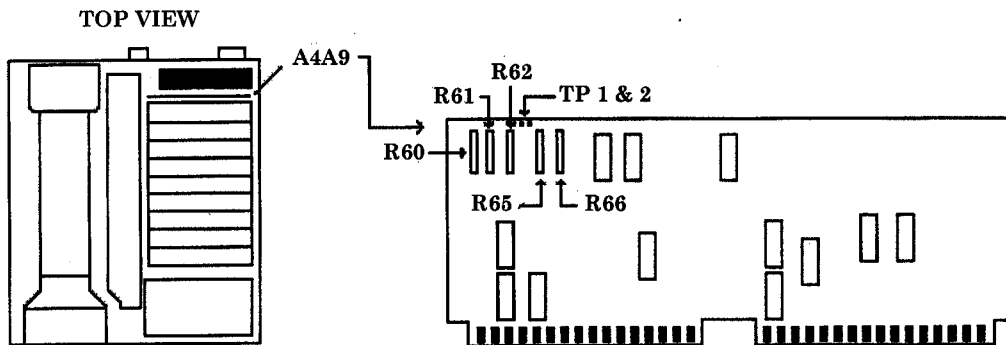

Figure 8. A4A9 board.

- (7) Press TI **MARKER Δ** key.
- (8) Adjust TI **DATA** knob to set marker to the -3 dB point on the negative going side of the displayed signal. There are now two markers; one on each side of the signal at the -3 dB points.
- (9) TI **MKR Δ** indication should be 3.00 ± 0.60 MHz.
- (10) Press TI keys as listed in (a) through (i) below:
- MARKER OFF.**
 - CENTER FREQUENCY, 100, MHz.**
 - FREQUENCY SPAN, 2, MHz.**
 - RES BW, 1, MHz.**
 - REFERENCE LEVEL, 10, -dBm.**
 - SCALE LIN.**
 - SHIFT.**
 - AUTO^A.**
 - REFERENCE LEVEL.**
- (11) Adjust **DATA** knob to position trace at (or just below) reference level (top) graticule line.
- (12) Press TI keys as listed in (a) through (d) below:
- MARKER NORMAL.**
 - MARKER PEAK SEARCH.**
 - MARKER→CF.**

(d) **MARKER Δ.**

(13) Using TI **DATA** knob adjust marker down the positive going side of the displayed signal to the -3 dB point.

(14) Adjust A4A9R61 (fig. 8) for a **MKR Δ** indication of 500 kHz while maintaining marker at the -3 dB point using TI **DATA** knob (R).

(15) Press TI **MARKER Δ** key.

(16) Using TI **DATA** knob, adjust marker to the -3 dB point on the negative going side of the displayed signal. There are now two markers; one on each side of the signal at the -3 dB points.

(17) TI **MKR Δ** indication should be 1.00 ± 0.10 MHz.

(18) Press TI keys as listed in (a) through (i) below:

- (a) **MARKER OFF.**
- (b) **CENTER FREQUENCY, 100, MHz.**
- (c) **FREQUENCY SPAN, 500, kHz.**
- (d) **RES BW, 300, kHz.**
- (e) **REFERENCE LEVEL, 10, -dBm.**
- (f) **SCALE LIN.**
- (g) **SHIFT.**
- (h) **AUTO^A.**
- (i) **REFERENCE LEVEL.**

(19) Adjust **DATA** knob to position trace at (or just below) reference level (top) graticule line.

(20) Press TI keys as listed in (a) through (d) below:

- (a) **MARKER NORMAL.**
- (b) **MARKER PEAK SEARCH.**
- (c) **MARKER→CF.**
- (d) **MARKER Δ.**

(21) Adjust TI **DATA** knob to place marker down the positive going side of the displayed signal to the -3 dB point.

(22) Adjust A4A9R62 (fig. 8) for a **MKR Δ** indication of 150 kHz while maintaining marker at the -3 dB point using TI **DATA** knob (R).

(23) Press TI **MARKER Δ** key.

(24) Adjust TI **DATA** knob to set marker to the -3 dB point on the negative going side of the displayed signal. There are now two markers; one on each side of the signal at the -3 dB points.

(25) TI **MKR Δ** indication should be 300 ± 30.0 kHz.

(26) Press TI keys as listed in (a) through (i) below:

- (a) **MARKER OFF.**
- (b) **CENTER FREQUENCY, 100, MHz.**
- (c) **FREQUENCY SPAN, 20, kHz.**
- (d) **RES BW, 10, kHz.**
- (e) **REFERENCE LEVEL, 10, -dBm.**

- (f) **SCALE LIN.**
- (g) **SHIFT.**
- (h) **AUTO^A.**
- (i) **REFERENCE LEVEL.**

(27) Adjust **DATA** knob to position trace at (or just below) reference level (top) graticule line.

(28) Press TI keys as listed in (a) through (d) below:

- (a) **MARKER NORMAL.**
- (b) **MARKER PEAK SEARCH.**
- (c) **MARKER→CF.**
- (d) **MARKER Δ.**

(29) Adjust TI **DATA** knob to place marker down the positive going side of the displayed signal to the -3 dB point.

(30) Adjust A4A9R65 (fig. 8) for a **MKR Δ** indication of 5 kHz while maintaining marker at the -3 dB point using TI **DATA** knob (R).

(31) Press TI **MARKER Δ** key.

(32) Adjust TI **DATA** knob to set marker to the -3 dB point on the negative going side of the displayed signal. There are now two markers; one on each side of the signal at the -3 dB points.

(33) TI **MKR Δ** indication should be 10 ± 1.0 kHz.

(34) Press TI keys as listed in (a) through (i) below:

- (a) **MARKER OFF.**
- (b) **CENTER FREQUENCY, 100, MHz.**
- (c) **FREQUENCY SPAN, 5, kHz.**
- (d) **RES BW, 3, kHz.**
- (e) **REFERENCE LEVEL, 10, -dBm.**
- (f) **SCALE LIN.**
- (g) **SHIFT.**
- (h) **AUTO^A.**
- (i) **REFERENCE LEVEL.**

(35) Adjust **DATA** knob to position trace at (or just below) reference level (top) graticule line.

(36) Press TI keys as listed in (a) through (d) below:

- (a) **MARKER NORMAL.**
- (b) **MARKER PEAK SEARCH.**
- (c) **MARKER→CF.**
- (d) **MARKER Δ.**

(37) Adjust TI **DATA** knob to place marker down the positive going side of the displayed signal to the -3 dB point.

(38) Adjust A4A9R66 (fig. 8) for a **MKR Δ** indication of 1.5 kHz while maintaining marker at the -3 dB point using TI **DATA** knob (R).

(39) Press TI **MARKER Δ** key.

(40) Adjust TI **DATA** knob to set marker to the -3 dB point on the negative going side of the displayed signal. There are now two markers; one on each side of the signal at the -3 dB points.

- (41) TI **MKR Δ** indication should be 3.0 ± 0.30 kHz.
- (42) Press TI **2-22 GHz** key.
- (43) Replace TI top cover.

13. Bandwidth Switching

a. Performance Check

- (1) Press TI **2-22 GHz** key.
- (2) Connect TI **CAL OUTPUT** to TI **RF INPUT**.
- (3) Press TI keys as listed in (a) through (f) below:
 - (a) **CENTER FREQUENCY, 100, MHz.**
 - (b) **FREQUENCY SPAN, 5, MHz.**
 - (c) **REFERENCE LEVEL, 8, -dBm.**
 - (d) **RES BW, 1, MHz.**
 - (e) **LOG ENTER dB / DIV, 1, dB.**
 - (f) **MARKER PEAK SEARCH, Δ .**
- (4) Press TI **MARKER PEAK SEARCH** key.
- (5) Read the amplitude deviation from the marker Δ indication. If indication displayed is not within limits specified in first row of table 9, perform **b** below.
- (6) Repeat technique of (3) (b), (d), (4) and (5) above for remaining TI **RES BW** and **FREQUENCY SPAN** key settings in table 9. If indications displayed are not within limits specified in table 9, perform **b** below.

Table 9. Bandwidth Switching Accuracy

Test instrument			
RES BW key	FREQUENCY SPAN key	Deviation (dB)	
		Min	Max
1 MHz	5 MHz	0 (ref)	0 (ref)
3 MHz	5 MHz	-1.00	1.00
300 kHz	5 MHz	-0.50	0.50
100 kHz	500 kHz	-0.50	0.50
30 kHz	500 kHz	-0.50	0.50
10 kHz	50 kHz	-0.50	0.50
3 kHz	50 kHz	-0.50	0.50
1 kHz	10 kHz	-0.50	0.50
300 Hz	1 kHz	-0.50	0.50
100 Hz	1 kHz	-0.50	0.50
30 Hz	200 Hz	-0.80	0.80
10 Hz	100 Hz	-2.00	2.00

b. Adjustments

- (1) Set TI **LINE** switch to **STANDBY**.
- (2) Remove TI top cover.

- (3) Set TI **LINE** switch to **ON**.
- (4) Press TI keys as listed in (a) through (h) below:
 - (a) **2-22 GHz**.
 - (b) **CENTER FREQUENCY, 100, MHz**.
 - (c) **FREQUENCY SPAN, 0, Hz**.
 - (d) **ATTEN, 0, dB**.
 - (e) **RES BW, 1, kHz**.
 - (f) **SCALE LIN**.
 - (g) **MARKER Δ**.
 - (h) **RES BW, 1, MHz**.

(5) Adjust A4A6R29 (fig. 9) to align markers on TI display. **MKR Δ** level should indicate 1.00X.

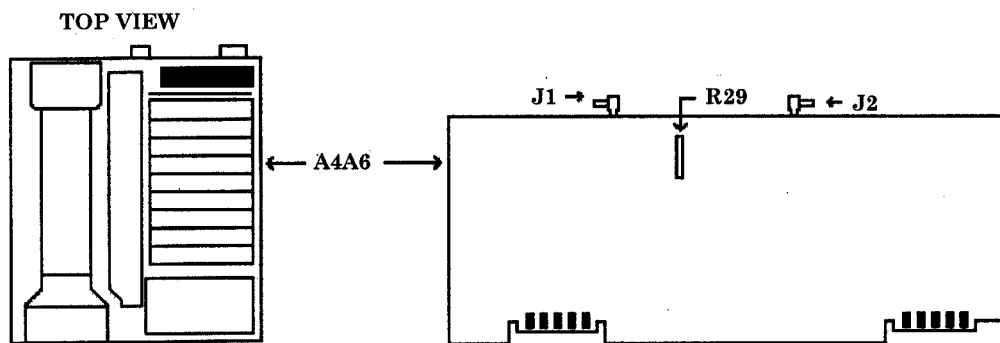

Figure 9. A4A6 board.

- (6) Press TI keys as listed in (a) and (b) below:
 - (a) **2-22 GHz**.
 - (b) **RECALL, 9**.
- (7) Adjust TI **FREQ ZERO** for maximum trace amplitude.

NOTE

The pictured filter (fig. 10) is required to continue with this adjustment procedure.

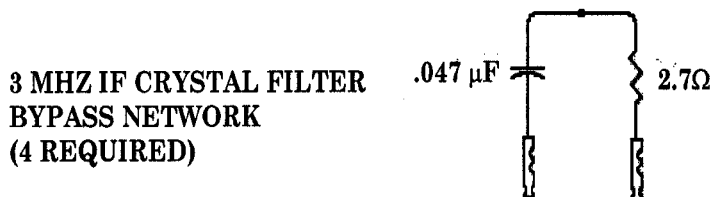

Figure 10. Filter.

- (8) Press TI keys as listed in (a) through (e) below:

- (a) **CENTER FREQUENCY, 100, MHz.**
- (b) **FREQUENCY SPAN, 10, kHz.**
- (c) **RES BW, 1, kHz.**
- (d) **SCALE LIN.**
- (e) **REFERENCE LEVEL.**

(9) Adjust TI DATA knob to position trace at (or just below) reference level (top) graticule line.

(10) Connect crystal filter bypass networks (fig. 10) between A4A7TP1 and A4A7TP2, A4A7TP3 and A4A7TP4, A4A7TP5 and A4A7TP6, A4A7TP7 and A4A7TP8 (fig. 11).

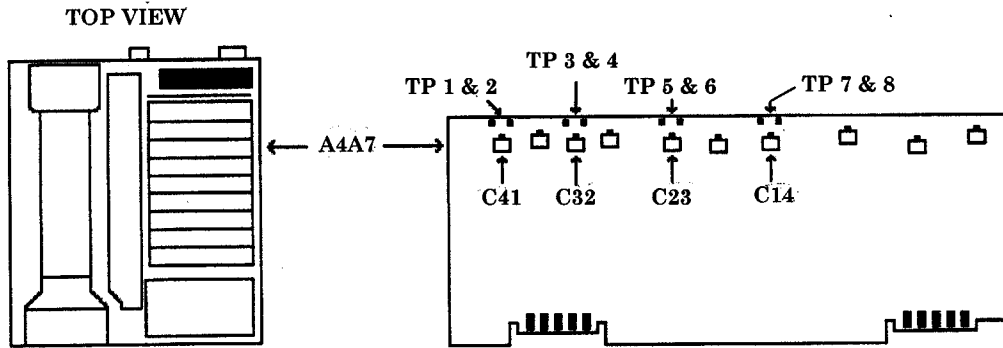

Figure 11. A4A7 board - test points.

- (11) Adjust A4A7C7 (fig. 12) for minimum signal peak amplitude.
- (12) Adjust A4A7C6 (fig. 12) for best symmetry of signal.
- (13) Repeat (11) and (12) above to ensure signal is nulled and adjusted for best symmetry.

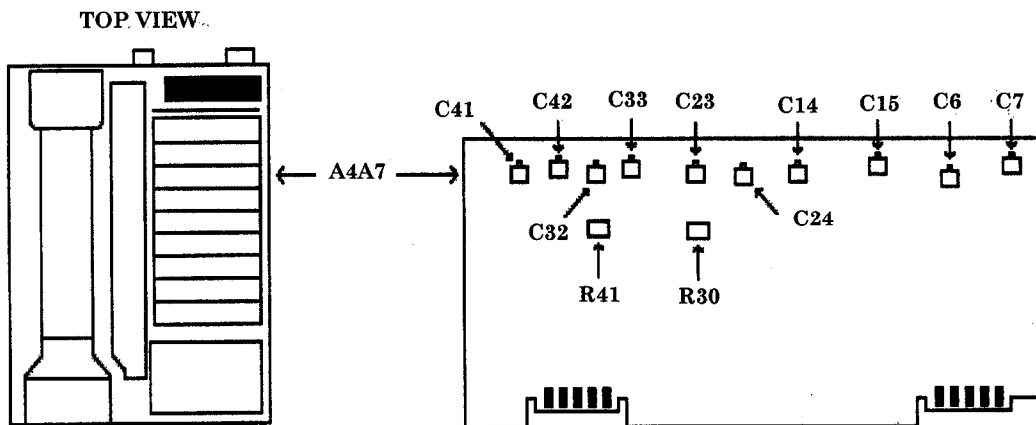

Figure 12. A4A7 board view 1.

(14) Remove crystal filter bypass networks from between A4A7TP7 and A4A7TP8 (fig. 11).

(15) Adjust A4A7C15 (fig. 12) for minimum signal peak amplitude.

(16) Adjust A4A7C14 (fig. 12) for best symmetry of signal.

(17) Repeat (15) and (16) above to ensure signal is nulled and adjusted for best symmetry.

(18) Remove crystal filter bypass networks from between A4A7TP5 and A4A7TP6 (fig. 11).

(19) Adjust A4A7C24 (fig. 12) for minimum signal peak amplitude.

(20) Adjust A4A7C23 (fig. 12) for best symmetry of signal.

(21) Repeat (19) and (20) above to ensure signal is nulled and adjusted for best symmetry.

(22) Remove crystal filter bypass networks from between A4A7TP3 and A4A7TP4 (fig. 11).

(23) Adjust A4A7C33 (fig. 12) for minimum signal peak amplitude.

(24) Adjust A4A7C32 (fig. 12) for best symmetry of signal.

(25) Repeat (23) and (24) above to ensure signal is nulled and adjusted for best symmetry.

(26) Remove crystal filter bypass networks from between A4A7TP1 and A4A7TP2 (fig. 11).

(27) Adjust A4A7C42 (fig. 12) for minimum signal peak amplitude.

(28) Adjust A4A7C41 (fig. 12) for best symmetry of signal.

(29) Repeat (27) and (28) above to ensure signal is nulled and adjusted for best symmetry.

(30) Press TI keys as listed in (a) through (d) below:

(a) **2-22 GHz.**

(b) **SWEEP TIME, 20, mSEC.**

(c) **RES BW, 10, Hz.**

(d) **REFERENCE LEVEL, 20, -dBm.**

(31) Set synthesizer/level generator for an output frequency of 21.4 MHz and an output level of -10 dBm.

(32) Disconnect 97 (white/violet) cable from A4A8J1 (fig. 13) and connect synthesizer/level generator **50Ω OUTPUT** to A4A8J1.

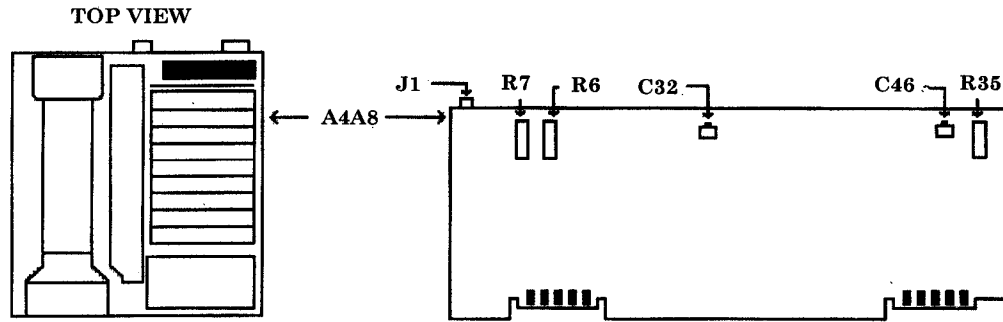

Figure 13. A4A8 board.

(33) Set up oscilloscope **Vertical 1** for 5 mV/div, 200 ns/div and ac coupled. Set up **Vertical 2** for 50 mV/div, and ac coupled. Set **Trigger** to **Sweep Auto**, **SOURCE 1**, and **Coupling AC**.

(34) Using a X10 probe, connect oscilloscope **Vertical 1** input to A4A7TP7 and **Vertical 2** input to A4A7TP5 (fig. 11).

(35) Adjust synthesizer/level generator frequency to peak **Vertical 1** display on oscilloscope.

(36) Adjust A4A7C13 (fig. 14) for a maximum peak-to-peak signal on oscilloscope **Vertical 2** display.

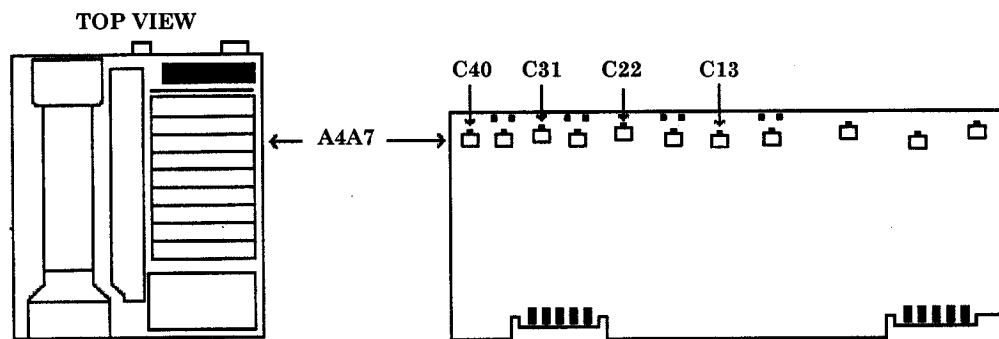

Figure 14. A4A7 board view 2.

(37) Move oscilloscope **Vertical 2** probe to A4A7TP3 (fig. 11).

(38) Adjust synthesizer/level generator frequency to peak **Vertical 1** display on oscilloscope.

(39) Adjust A4A7C22 (fig. 14) for a maximum peak-to-peak signal on oscilloscope **Vertical 2** display.

(40) Move oscilloscope **Vertical 2** probe to A4A7TP1 (fig. 11).

- (41) Adjust synthesizer/level generator frequency to peak **Vertical 1** display on oscilloscope.
- (42) Adjust A4A7C31 (fig. 14) for a maximum peak-to-peak signal on oscilloscope **Vertical 2** display.
- (43) Disconnect oscilloscope **Vertical 2** probe from A4A7TP1 (fig. 11).
- (44) Adjust synthesizer/level generator frequency to peak **Vertical 1** display on oscilloscope.
- (45) Press TI **REFERENCE LEVEL** key.
- (46) Adjust TI **DATA** knob to position trace at (or just below) reference level (top) graticule line.
- (47) Adjust A4A7C40 (fig. 14) for a maximum signal amplitude on TI display.
- (48) Disconnect oscilloscope **Vertical 1** probe from A4A7TP7 (fig. 11).
- (49) Disconnect synthesizer/level generator from A4A8J1 (fig. 13) and reconnect 97 (white/violet) cable.
- (50) Press TI keys as listed in (a) through (c) below:
 - (a) **2-22 GHz**.
 - (b) **RECALL, 9**.
 - (c) **RES BW, 10, Hz**.
- (51) Adjust TI front panel **FREQ ZERO** for maximum signal amplitude on TI display.
- (52) Press TI keys as listed in (a) and (b) below:
 - (a) **RES BW, 1, kHz**.
 - (b) **DISPLAY LINE ENTER**.
- (53) Using TI **DATA** knob, place display line at the signal trace on TI.
- (54) Press TI **RES BW, 10, Hz** keys.
- (55) Adjust TI front panel **FREQ ZERO** for maximum signal amplitude on TI display.
- (56) Adjust A4A7R30 and A4A7R41 (fig. 12) equal amounts to set the signal level the same as the reference level.
- (57) Press TI **2-22 GHz** key.
- (58) Connect multimeter **HI** to A4A5TP1 (fig. 15) and multimeter **LO** to chassis.

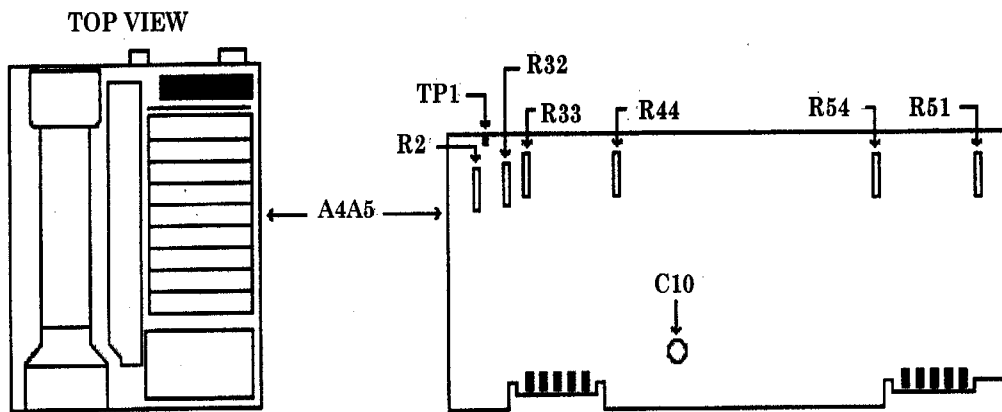

Figure 15. A4A5 board.

- (59) Multimeter should indicate between 8.5 and 11.0 V dc. If measurement is out of tolerance, adjust A4A5R2 for a multimeter indication of 9.5 ± 0.1 V dc (R).
- (60) Connect equipment as shown in figure 16 below.
- (61) Set both attenuators to 0 dB.
- (62) Disconnect 97 (white/violet) cable from A4A8J1 (fig. 13).
- (63) Disconnect 89 (gray/white) cable from A4A6J1 (fig. 9).
- (64) Connect 97 (white/violet) cable to A4A6J1 (fig. 9).

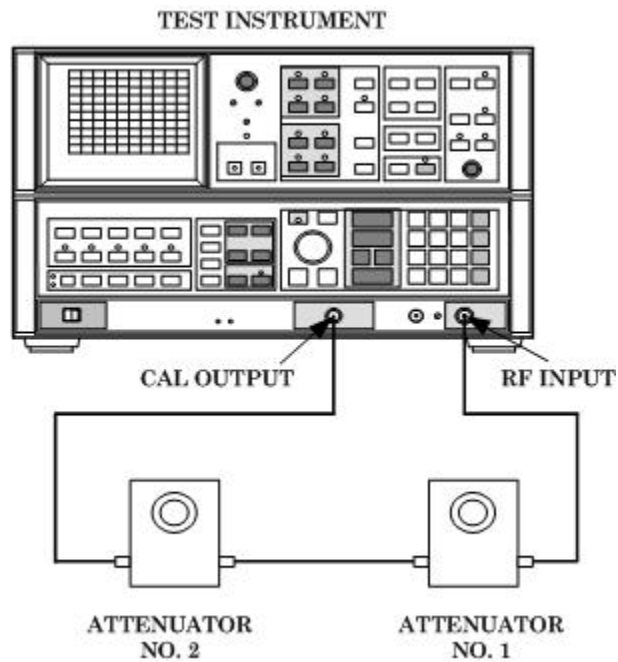

Figure 16. Attenuator connection.

(65) Press TI keys as listed in (a) through (e) below:

- (a) **RES BW, 1, MHz.**
- (b) **FREQUENCY SPAN, 200, kHz.**
- (c) **MARKER NORMAL.**
- (d) **SCALE LIN.**
- (e) **REFERENCE LEVEL.**

(66) Adjust TI **DATA** knob to position trace at (or just below) reference level (top) graticule line.

(67) Short A4A9TP1 to A4A9TP2 (fig. 8).

(68) Adjust A4A4C67 and A4A4C19 (fig. 17) for maximum level as indicated by TI indication.

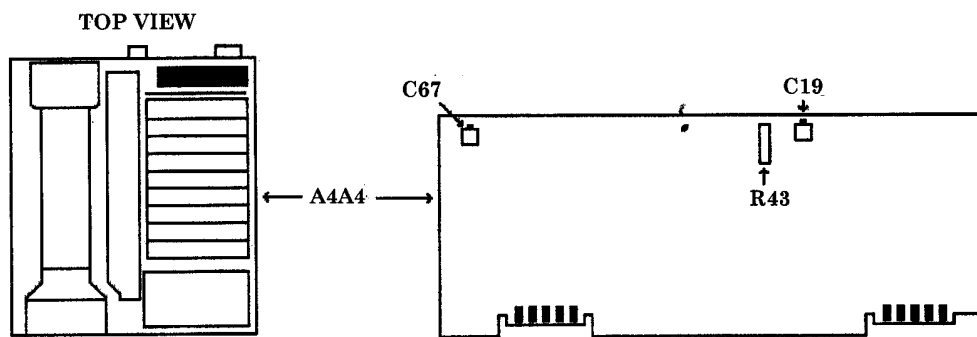

Figure 17. A4A4 board.

(69) Remove short from A4A9TP1 and A4A9TP2 (fig. 8).

(70) Press TI **MARKER Δ** key.

(71) Reinstall short between A4A9TP1 and A4A9TP2 (fig. 8).

(72) Adjust A4A4R43 (fig. 17) to align markers on TI display. **MKR Δ** level should indicate 1.00X.

NOTE

The pictured filter (fig. 18) is required to continue with this adjustment routine.

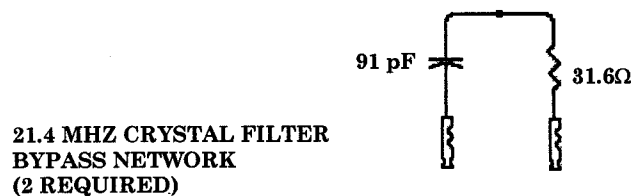

Figure 18. 21.4 MHz filter.

(73) Press TI keys as listed in (a) through (e) below:

- (a) **MARKER OFF.**
- (b) **RES BW, 30, kHz.**
- (c) **FREQUENCY SPAN, 100, kHz.**
- (d) **SCALE LIN.**
- (e) **REFERENCE LEVEL.**

(74) Adjust TI **DATA** knob to position trace at (or just below) reference level (top) graticule line.

(75) Connect 21.4 MHz CRYSTAL FILTER BYPASS NETWORK(S) (fig. 18) between A4A4TP1 and A4A4TP2 and between A4A4TP4 and A4A4TP5 (fig. 19).

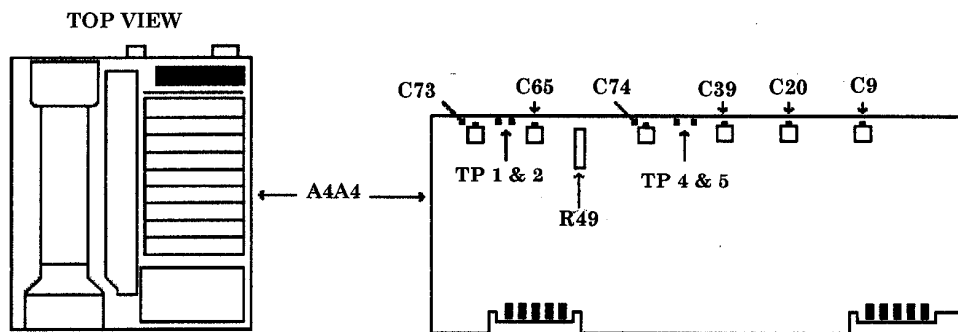

Figure 19. A4A4 test points.

(76) Adjust A4A4C20 (fig. 19) to center signal on center vertical graticule line.

(77) Adjust A4A4C9 (fig. 19) for best symmetry of signal.

(78) Remove 21.4 MHz CRYSTAL FILTER BYPASS NETWORK(S) (fig. 18) from between A4A4TP4 and A4A4TP5 (fig. 19).

(79) Adjust A4A4C74 (fig. 19) to center signal on center vertical graticule line.

(80) Adjust A4A4C39 (fig. 19) for best symmetry of signal.

(81) Remove 21.4 MHz CRYSTAL FILTER BYPASS NETWORK(S) (fig. 18) from between A4A4TP1 and A4A4TP2 (fig. 19).

(82) Adjust A4A4C73 (fig. 19) to center signal on center vertical graticule line.

(83) Adjust A4A4C65 (fig. 19) for best symmetry of signal.

(84) Press TI keys as listed in (a) through (c) below:

- (a) **MARKER Δ.**
- (b) **FREQUENCY SPAN, 20, kHz.**
- (c) **RES BW, 3, kHz.**

(85) Adjust A4A4R49 (fig. 19) to align markers on TI display. **MKR Δ** level should indicate 1.00X.

(86) Disconnect 97 (white/violet) cable from A4A6J1 (fig. 9).

- (87) Connect 97 (white/violet) cable to A4A8J1 (fig. 13).
- (88) Connect 89 (gray/white) cable to A4A6J1 (fig. 9).
- (89) Press TI keys as listed in (a) through (d) below:
- MARKER NORMAL.**
 - RES BW, 1, MHz.**
 - FREQUENCY SPAN, 200, kHz.**
 - REFERENCE LEVEL.**
- (90) Adjust TI **DATA** knob to position trace at (or just below) reference level (top) graticule line.
- (91) Adjust A4A8C32 and A4A8C46 (fig. 13) for maximum **MKR LVL** as by TI annotation.
- (92) Remove short from A4A9TP1 and A4A9TP2 (fig. 8).
- (93) Press TI **MARKER Δ** key.
- (94) Reinstall short between A4A9TP1 and A4A9TP2 (fig. 8).
- (95) Adjust A4A8R35 (fig. 13) to align markers on TI display. **MKR Δ LVL** indication should be 1.00X.
- (96) Remove short from A4A9TP1 and A4A9TP2 (fig. 8).
- (97) Press TI keys as listed in (a) through (c) below:
- MARKER OFF.**
 - RES BW, 30, kHz.**
 - FREQUENCY SPAN, 100, kHz.**
- (98) Connect 21.4 MHz CRYSTAL FILTER BYPASS NETWORK(S) (fig. 18) between A4A8TP1 and A4A8TP2 (fig. 20).

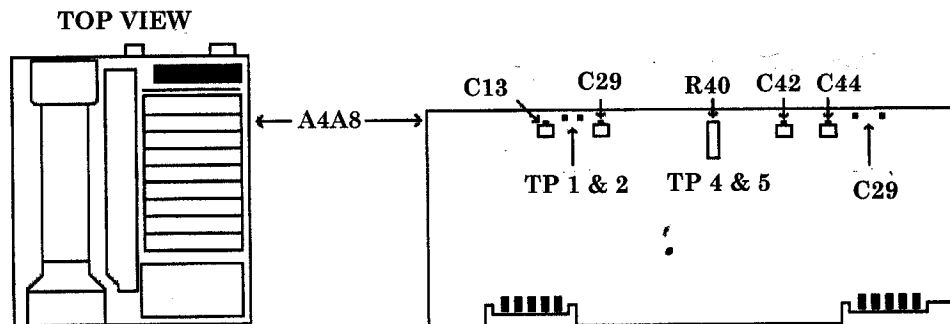

Figure 20. A4A8 board.

- (99) Adjust A4A8C44 (fig. 20) to center signal on center vertical graticule line.
- (100) Adjust A4A8C42 (fig. 20) for best symmetry of signal.
- (101) Remove 21.4 MHz CRYSTAL FILTER BYPASS NETWORK(S) (fig. 18) from between A4A8TP1 and A4A8TP2 (fig. 20).
- (102) Connect 21.4 MHz CRYSTAL FILTER BYPASS NETWORK(S) (fig. 18) between A4A8TP4 and A4A8TP5 (fig. 20).

(103) Adjust A4A8C29 (fig. 20) to center signal on center vertical graticule line.

(104) Adjust A4A8C13 (fig. 20) for best symmetry of signal.

(105) Remove 21.4 MHz CRYSTAL FILTER BYPASS NETWORK(S) (fig. 18) from between A4A8TP4 and A4A8TP5 (fig. 20).

(106) Press TI keys as listed in (a) through (c) below:

(a) **FREQUENCY SPAN, 10, kHz.**

(b) **MARKER Δ.**

(c) **RESA BW, 3, kHz.**

(107) Adjust A4A8R40 (fig. 20) to align markers on display. **MKR LVL** should indicate 1.00X.

(108) Press TI **2-22 GHz** key.

(109) Set attenuators for 25 dB.

(110) Press TI keys as listed in (a) through (h) below:

(a) **CENTER FREQUENCY, 100, kHz.**

(b) **FREQUENCY SPAN, 3, kHz.**

(c) **RES BW, 1, kHz.**

(d) **ATTEN, 0, dB.**

(e) **REFERENCE LEVEL, 30, -dBm.**

(f) **SCALE LOG, 1, dBm.**

(g) **MARKER Δ.**

(h) **REFERENCE LEVEL, 20, -dBm.**

(111) Set attenuators for 15 dB.

(112) Adjust A4A8R7 (fig. 13) to align markers on display. **MKR Δ LVL** should indicate 0.00dB.

(113) Press TI **REFERENCE LEVEL, 10,** and **-dBm** keys.

(114) Set attenuators for 5 dB.

(115) Adjust A4A8R6 (fig. 13) to align markers on display. **MKR Δ LVL** should indicate 0.00dB.

(116) Press TI **2-22 GHz** key.

(117) Set TI **LINE** switch to **STANDBY.**

(118) Replace TI top cover.

14. Log Scale Switching

a. Performance Check

(1) Press TI **2-22 GHz** key.

(2) Connect TI **CAL OUTPUT** to TI **RF INPUT.**

(3) Press TI keys as listed in (a) through (e) below:

(a) **CENTER FREQUENCY, 100, MHz.**

(b) **FREQUENCY SPAN, 100, kHz.**

(c) **REFERENCE LEVEL, 8, -dBm.**

- (d) **RES BW, 30, kHz.**
- (e) **LOG ENTER dB/DIV, 1, dB.**

(4) Press TI **MARKER PEAK SEARCH** and **MARKER → REF LEVEL** and record the displayed marker amplitude in first row (Reference Indication column) of table 10.

(5) Press the TI **↑**, and **MARKER PEAK SEARCH** keys and record displayed amplitude level in table 10.

(6) Repeat (5) above for remaining log scales and calculate log scale deviation using the formula below. If calculated deviation is not within limits specified in table 10, perform **b** below.

$$\text{Marker amplitude} - \text{reference indication} = \text{deviation}$$

Table 10. Log Scale Deviation

Test Instrument				
SCALE (dB/div)	MKR amplitude (dBm)	(Reference indication) (dBm)	Calculated deviation (dB)	
			Min	Max
1		()	0 (ref)	0 (ref)
2		()	-0.5	0.5
5		()	-0.5	0.5
10		()	-0.5	0.5

b. Adjustments

- (1) Set TI **LINE** switch to **STANDBY**.
- (2) Remove TI top cover.
- (3) Remove cables attached to the A3 digital storage cage.
- (4) Remove digital storage cage cover.
- (5) Reconnect cables to digital storage cage removed in (3) above.
- (6) Connect TI **RF INPUT** to TI **CAL OUTPUT** through attenuator No. 2.
- (7) Set TI **LINE** switch to **ON**.
- (8) Press TI **2-22 GHz** key.
- (9) Connect multimeter **HI** to A4A1TP1 (fig. 21) and multimeter **LO** to A3A9TP1 (fig. 22).

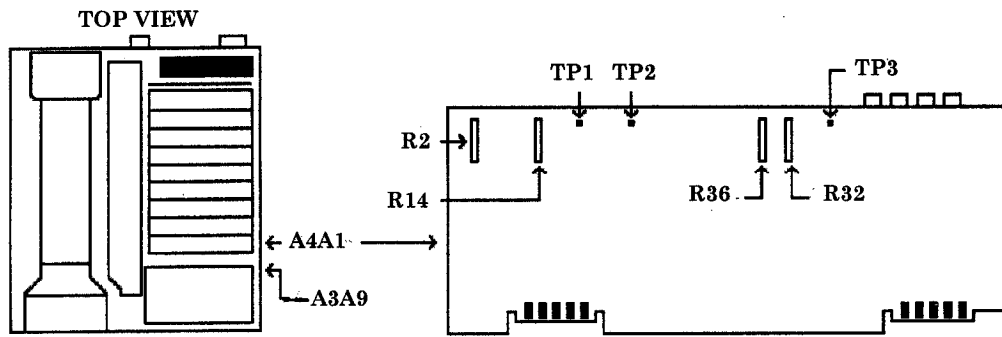

Figure 21. A4A1 board.

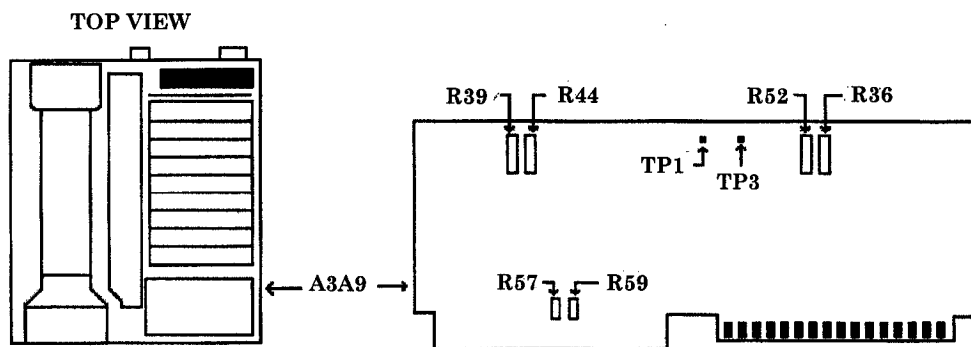

Figure 22. A3A9 board.

- (10) Press TI keys as listed in (a) through (c) below:
 - (a) **CENTER FREQUENCY, 100, MHz.**
 - (b) **FREQUENCY SPAN, 0, Hz.**
 - (c) **SCALE LIN.**
- (11) Set attenuator No. 2 to 120 dB. Multimeter indication should be 0.000 ± 0.001 V dc (R).
- (12) Connect multimeter **HI** to A4A1TP2 (fig. 21).
- (13) Adjust A4A1R14 (fig. 21) for a multimeter indication of -5.000 ± 0.003 V dc (R).
- (14) Connect multimeter **HI** to A4A1TP1 (fig. 21).
- (15) Set attenuator No. 2 to 0 dB.
- (16) Press TI **REFERENCE LEVEL** key.
- (17) Adjust TI **DATA** knob for a multimeter indication as close to 1.000 ± 0.001 V dc as possible. (It may be necessary to slightly adjust the TI **AMPTD CAL** control to achieve required tolerance).
- (18) Press TI **SCALE LOG, 1, dBm** keys.
- (19) Connect multimeter **HI** to A4A1TP3 (fig. 21) and multimeter **LO** to chassis.

- (20) Adjust A4A1R14 (fig. 21) for a multimeter indication of 2.000 ± 0.010 V dc (R).
- (21) Set attenuator No. 2 to 120 dB.
- (22) Adjust A4A1R32 (fig. 21) for a multimeter indication of 0.000 ± 0.001 V dc (R).
- (23) Press TI keys as listed in (a) through (f) below:
 - (a) **SHIFT.**
 - (b) **ATTEN.**
 - (c) **SCALE LOG.**
 - (d) **SHIFT.**
 - (e) **SCALE LOG.**
 - (f) **REFERENCE LEVEL, 50, -dBm.**
- (24) Set attenuator No. 2 to 40 dB.
- (25) Connect multimeter **HI** to A4A1TP1 (fig. 21). Record multimeter indication.
- (26) Press TI **REFERENCE LEVEL, 60, -dBm** keys.
- (27) Adjust A4A1R2 (fig. 21) for a multimeter indication 0.100 ± 0.001 V dc greater than the indication recorded in (25) above (R).
- (28) Press TI **REFERENCE LEVEL, 70, -dBm** keys.
- (29) Multimeter indication should be 0.200 ± 0.002 V dc greater than the indication recorded in (25) above. If not, readjust A4A1R2 (fig. 21).
- (30) Press TI **REFERENCE LEVEL, 90, and -dBm** keys.
- (31) Multimeter indication should be 0.400 ± 0.004 V dc greater than the indication recorded in (25) above. If not, readjust A4A1R2 (fig. 21).
- (32) Press TI **2-22 GHz** key.
- (33) Set TI **LINE** switch to **STANDBY**.
- (34) Remove cables attached to the A3 digital storage cage.
- (35) Replace digital storage cage cover.
- (36) Reconnect cables to digital storage cage removed in (34) above.
- (37) Replace TI top cover.
- (38) Set TI **LINE** switch to **ON**.
- (39) Remove attenuator No. 2 from equipment setup.

15. IF Gain Uncertainty

a. Performance Check

- (1) Press TI **2-22 GHz**.
- (2) Connect TI **CAL OUTPUT** to TI **RF INPUT**.
- (3) Press TI **RECALL, 8**.
- (4) Adjust TI **AMPTD CAL** control for a **MARKER** amplitude indication of -10.00 ± 0.02 dBm on the TI display.
- (5) Press TI **2-22 GHz** key.
- (6) Connect equipment as shown in fig. 23.

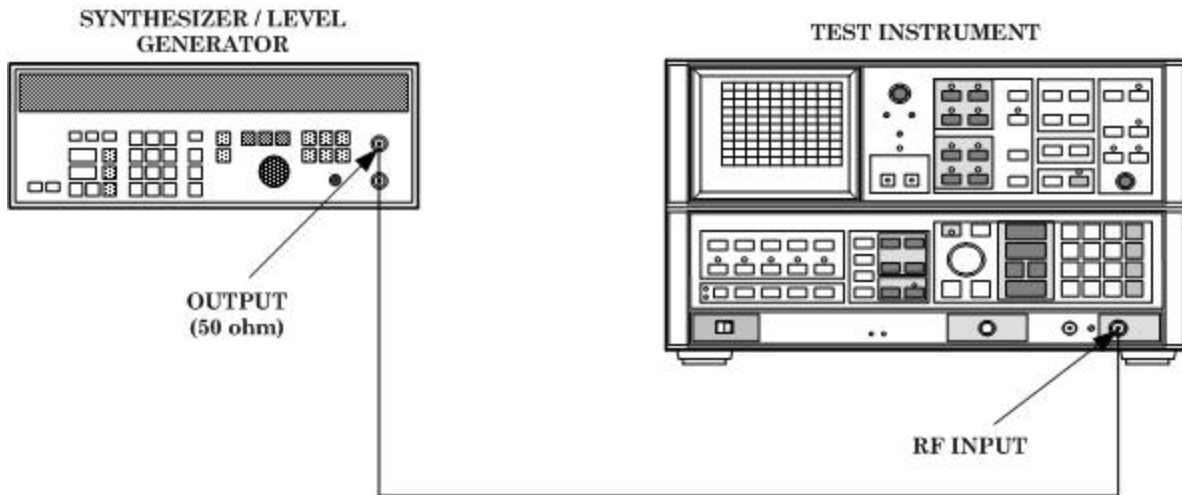

Figure 23. IF gain equipment setup.

(7) Set the synthesizer/level generator for an output frequency of 20.0010 MHz, output amplitude of -2.0 dBm, and amplitude increment steps of 10 dB.

- (8) Press TI keys as listed in (a) through (j) below:
 - (a) **CENTER FREQUENCY, 20.001, MHz.**
 - (b) **FREQUENCY SPAN, 2, kHz.**
 - (c) **MARKER PEAK SEARCH.**
 - (d) **MARKER → CF.**
 - (e) **REFERENCE LEVEL, 0, dBm.**
 - (f) **VIDEO BW, 100, Hz.**
 - (g) **RES BW, 1 kHz.**
 - (h) **LOG ENTER dB/DIV, 1, dB.**
 - (i) **MARKER PEAK SEARCH, Δ.**
 - (j) **SHIFT, ATTN.**

(9) Read the amplitude deviation from TI marker Δ indication. Record displayed amplitude level in deviation marker Δ amplitude indication column of table 11.

(10) Repeat technique of (7), (8) (e), (f), and (9) above for remaining TI **REFERENCE LEVEL**, **VIDEO BW** and synthesizer/level generator settings in table 11.

Table 11. IF Gain Uncertainty (10 dB Steps)

Synthesizer/level generator	Test instrument		
	Amplitude (dBm)	Reference level (dBm)	Video BW (Hz)
-2	0	100	
-12	-10	100	
-22	-20	100	
-32	-30	100	
-42	-40	100	
-52	-50	100	
-62	-60	10	
-72	-70	10	
-32	-80 ¹	100	
-42	-90	100	
-52	-100	10	
-62	-110	10	
-72	-120	10	

¹Press TI **SHIFT**, and **ENTER dB/DIV** keys.

(11) Press TI keys as listed in (a) through (e) below:

- (a) **2-22 GHz.**
- (b) **RECALL, 7.**
- (c) **REFERENCE LEVEL, 1.9, dBm.**
- (d) **MARKER OFF.**
- (e) **VIDEO BW, 100, Hz.**

(12) Change the synthesizer/level generator output level to -3.9 dBm and amplitude increments to 2 dB steps.

(13) Press TI **MARKER PEAK SEARCH**, and **Δ** keys

(14) Read the amplitude deviation from TI **MARKER Δ** readout. Record displayed amplitude level in deviation marker Δ amplitude indication column of table 12.

(15) Repeat technique of (11) (c), (12) and (14) above for remaining TI **REFERENCE LEVEL** and synthesizer/level generator settings in table12.

Table 12. IF Gain Uncertainty (2 dB Steps)

Synthesizer/level generator	Test instrument	
	Amplitude (dBm)	Reference level (dBm)
-3.9	-1.9	
-5.9	-3.9	
-7.9	-5.9	
-9.9	-7.9	
-11.9	-9.9	

(16) Press TI **MARKER OFF** key.

- (17) Press TI **REFERENCE LEVEL** key to select **0 dB**.
- (18) Change the synthesizer/level generator output level to -2.00 dBm and amplitude increments to 0.1 dB steps.
- (19) Press TI **MARKER PEAK SEARCH** and Δ keys.
- (20) Read the amplitude deviation from TI marker Δ readout. Record displayed amplitude level in deviation marker Δ amplitude indication column of table 13.
- (21) Repeat technique of (16) through (20) above for remaining TI **REFERENCE LEVEL** key and synthesizer/level generator settings in table 13.

Table 13. IF Gain Uncertainty (0.1 dB Steps)

Synthesizer/level generator	Test instrument	
	Reference level (dBm)	Deviation marker Δ amplitude indication (dB)
-2.00	0.0	
-2.10	-0.1	
-2.20	-0.2	
-2.30	-0.3	
-2.40	-0.4	
-2.50	-0.5	
-2.60	-0.6	
-2.70	-0.7	
-2.80	-0.8	
-2.90	-0.9	
-3.00	-1.0	
-3.10	-1.1	
-3.20	-1.2	
-3.30	-1.3	
-3.40	-1.4	
-3.50	-1.5	
-3.60	-1.6	
-3.70	-1.7	
-3.80	-1.8	
-3.90	-1.9	

- (22) Find the largest positive deviation recorded in table 11 from 0 to -70 dBm and record value in column (A) of table 14 below.
- (23) Find the largest negative deviation recorded in table 11 from 0 to -70 dBm and record value in column (B) of table 14 below.
- (24) Find the largest positive deviation recorded in table 11 from -80 dBm to -120 dBm and record value in column (C) of table 14 below.
- (25) Find the largest negative deviation recorded in table 11 from -80 dBm to -120 dBm and record value in column (D) of table 14 below.
- (26) Find the largest positive deviation recorded in table 12 and record value in column (E) of table 14 below.
- (27) Find the largest negative deviation recorded in table 12 and record value in column (F) of table 14 below.

(28) Find the largest positive deviation recorded in table 13 and record value in column (G) of table 14 below.

(29) Find the largest negative deviation recorded in table 13 and record value in column (H) of table 14 below.

Table 14. IF Gain Calculation Values

Table 11 values 0 to -70 dBm (10 dB steps)		Table 11 values -80 dBm to -120 dBm (10 dB steps)		Table 12 values (2 dB steps)		Table 13 values (0.1 dB steps)	
(A) +	(B) -	(C) +	(D) -	(E) +	(F) -	(G) +	(H) -

(30) Add the values in columns A, E, and G. If total sum exceeds 0.6 dB, perform **b** below.

(31) Add the values in columns B, F and H. If total sum exceeds -0.6 dB, perform **b** below.

(32) Add the values in columns A, C, E, and G. If total sum exceeds 1.0 dB, perform **b** below.

(33) Add the values in columns B, D, F, and H. If total sum exceeds -1.0 dB, perform **b** below.

b. Adjustments

- (1) Disconnect synthesizer/level generator **50Ω OUTPUT** from **TI RF INPUT**.
- (2) Set **TI LINE** switch to **STANDBY**.
- (3) Remove TI top cover.
- (4) Remove cables attached to the A3 digital storage cage.
- (5) Remove digital storage cage cover.
- (6) Reconnect cables to digital storage cage removed in (4) above.
- (7) Set **TI LINE** switch to **ON**.
- (8) Connect **TI RF INPUT** to **TI CAL OUTPUT**.
- (9) Press **TI 2-22 GHz** key.
- (10) Short A3A9TP1 to A3A9TP3 (fig. 22).
- (11) Disconnect 7 (violet) cable from A4A1J1 and terminate cable into a 50 Ω load.
- (12) Press TI keys as listed in (a) through (i) below:
 - (a) **CENTER FREQUENCY, 100, MHz.**
 - (b) **FREQUENCY SPAN, 0, Hz.**
 - (c) **SWEEP SINGLE.**
 - (d) **TRACE A CLEAR-WRITE.**
 - (e) **MARKER NORMAL.**
 - (f) **MARKER Δ.**
 - (g) **SWEEP CONT.**
 - (h) **SHIFT.**
 - (i) **TRACE A BLANK.**

(13) Adjust A3A9R59 (fig. 22) until TI **MKR Δ LVL** indication, as indicated by TI annotation, flickers back and forth between .00 and .10 dB.

- (14) Press TI **SHIFT** and **TRACE A MAX HOLD** keys.
- (15) Adjust A3A9R44 (fig. 22) until TI **MKR Δ LVL** indication, as indicated by TI annotation, flickers back and forth between .00 and .10 dB.
- (16) Press TI **SHIFT** and **TRACE A VIEW** keys.
- (17) Adjust A3A9R36 (fig. 22) until TI **MKR Δ LVL** indication, as indicated by TI annotation, flickers back and forth between .00 and .10 dB.
- (18) Press TI **SHIFT** and **TRACE A BLANK** keys.
- (19) Remove short from between A3A9TP1 to A3A9TP3 (fig. 22). Reconnect 7 (violet) cable to A4A1J1.
- (20) Connect multimeter **HI** to A4A1TP3 (fig. 21) and multimeter **LO** to A3A9TP1 (fig. 22).
- (21) Press TI **REFERENCE LEVEL** key.
- (22) Adjust TI **DATA** knob for a multimeter indication of 2.000 ± 0.001 V dc.
- (23) Disconnect multimeter from TI.
- (24) Press TI keys as listed in (a) through (e) below:
 - (a) **SWEEP SINGLE.**
 - (b) **TRACE A CLEAR-WRITE.**
 - (c) **MARKER NORMAL.**
 - (d) **MARKER Δ.**
 - (e) **SWEEP CONT.**
- (25) Adjust A3A9R57 (fig. 22) for a TI **MKR Δ LVL** indication, of 100 ± 0.1 dB on TI (R).
- (26) Press TI **SHIFT** and **TRACE A MAX HOLD** keys.
- (27) Adjust A3A9R39 (fig. 22) for a TI **MKR Δ LVL** indication, of 100 ± 0.1 dB on TI (R).
- (28) Press TI **SHIFT** and **TRACE A VIEW** keys.
- (30) Adjust A3A9R52 (fig. 22) for a TI **MKR Δ LVL** indication, of 100 ± 0.1 dB on TI (R).
- (31) Disconnect TI **RF INPUT** from TI **CAL OUTPUT**.
- (32) Press TI keys as listed in (a) through (f) below:
 - (a) **2-22 GHz.**
 - (b) **CENTER FREQUENCY, 7.6, MHz.**
 - (c) **FREQUENCY SPAN, 0, Hz.**
 - (d) **REFERENCE LEVEL, 10, +dBm.**
 - (e) **RES BW, 10, kHz.**
 - (f) **SCALE LIN.**
- (33) Connect multimeter **HI** to A4A1TP1 (fig. 21) and multimeter **LO** to A3A9TP1 (fig. 22).
- (34) Adjust A4A2R79 (fig. 24) for 0.0000 ± 0.0005 V dc

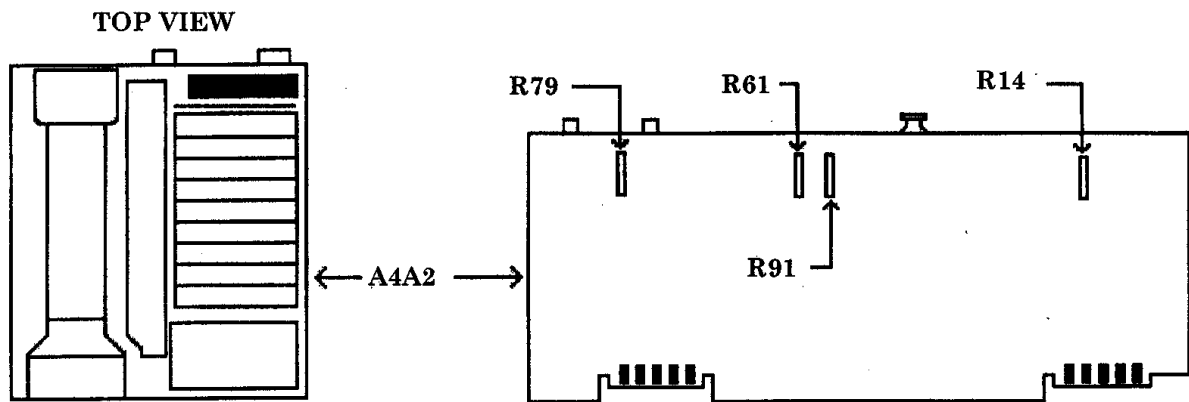

Figure 24. A4A2 board.

- (35) Press TI **SCALE LOG** key.
- (36) Connect TI **RF INPUT** to synthesizer/level generator **50Ω OUTPUT**.
- (37) Set synthesizer/level generator for an output frequency of 7.6 MHz at an output level of 5 dBm.
- (38) Adjust A4A3C55 (fig. 25) for a maximum multimeter indication.

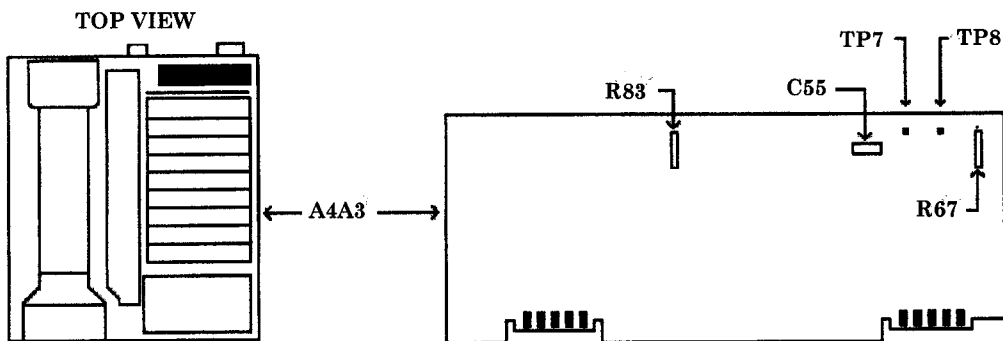

Figure 25. A4A3 board.

NOTE

If A4A3C55 is at an extreme of its adjustment range (fully meshed or unmeshed) then TI must be repaired.

- (39) Short A4A3TP7 to A4A3TP8 (fig. 25) and record multimeter indication.
- (40) Remove short from between A4A3TP7 and A4A3TP8.

(41) Adjust A4A3R67 (fig. 25) for a multimeter indication the same as that recorded in (39) above ± 0.0005 V dc (R). If TI cannot be adjusted to meet this tolerance then TI must be repaired.

(42) Press TI **SCALE LIN** key.

(43) Adjust synthesizer/level generator output level for a multimeter indication of 1.000 ± 0.002 V dc.

(44) Press TI **SCALE LOG** key.

(45) Decrease synthesizer/level generator output level by 50 dBm.

(46) Adjust A4A2R91 (fig. 24) for a multimeter indication of 0.500 ± 0.001 V dc (R).

(47) Increase synthesizer/level generator output level by 50 dBm.

(48) Adjust A4A2R61 (fig. 24) for a multimeter indication of 1.000 ± 0.001 V dc (R). If TI cannot be adjusted to meet this tolerance then TI must be repaired.

(49) Press TI **SCALE LIN** key.

(50) Multimeter should indicate 1.000 ± 0.020 V dc. If multimeter indication is out of tolerance then TI must be repaired.

(51) Press TI **REFERENCE LEVEL, 0**, and **dBm** keys.

(52) Adjust synthesizer/level generator output level for a multimeter indication of 1.000 ± 0.001 V dc.

(53) Press TI keys as listed in (a) through (c) below:

(a) **SHIFT**.

(b) **SCALE LOG**.

(c) **REFERENCE LEVEL, 60, -dBm**.

(54) Decrease synthesizer/level generator output level by 10 dBm.

(55) Adjust A4A3R83 (fig. 25) for a multimeter indication of 1.000 ± 0.010 V dc. If multimeter indication is out of tolerance then TI must be repaired.

(56) Press TI **REFERENCE LEVEL, 70**, and **-dBm** keys.

(57) Decrease synthesizer/level generator output level by 10 dBm.

(58) Adjust A4A2R14 (fig. 24) for a multimeter indication of 1.000 ± 0.010 V dc. If multimeter indication is out of tolerance then TI must be repaired.

(59) Press TI **2-22 GHz** key.

(60) Disconnect synthesizer/level generator **50Ω OUTPUT** from TI **RF INPUT**.

(61) Connect TI **CAL OUTPUT** to TI **RF INPUT**.

(62) Press TI keys as listed in (a) through (g) below:

(a) **CENTER FREQUENCY, 100, MHz**.

(b) **REFERENCE LEVEL, 10, -dBm**.

(c) **ATTEN, 0, dBm**.

(d) **FREQUENCY SPAN, 0, Hz**.

(e) **RES BW, 1, kHz**.

(f) **VIDEO BW, 100, Hz**.

(g) **SWEEP TIME, 20, mSEC**.

- (63) Disconnect 97 (white/violet) cable from A4A8J1 (fig. 13) and connect cable to measuring receiver power sensor.
- (64) Set measuring receiver to measure power.
- (65) Adjust TI **AMPTD CAL** control for a measuring receiver indication of -5 dBm.
- (66) Disconnect measuring receiver power sensor and reconnect 97 cable to A4A8J1 (fig. 13).
- (67) Press TI keys as listed in (a) and (b) below:
- (a) **SCALE LIN.**
 - (b) **MARKER NORMAL.**
- (68) Adjust A4A5R33 (fig. 15) for an indication of 70.7 mV on TI (R). Trace on TI should be at top graticule line.
- (69) Connect equipment as shown in figure 16.
- (70) Press TI **REFERENCE LEVEL, 30**, and **-dBm** keys.
- (71) Set attenuator No. 1 to 5 dB and attenuator No. 2 to 20 dB.
- (72) Press TI **MARKER Δ** key.
- (73) Signal trace should be at the center graticule line. TI **MKR Δ LVL** as, indicated by indication, should be .00 dB.
- (74) Press TI **REFERENCE LEVEL, 40**, and **-dBm** keys.
- (75) Set attenuator No. 2 to 30 dB.
- (76) Adjust A4A5R32 (fig. 15) for a TI **MKR Δ LVL** of .00 dB (**MKR Δ LVL** indication is now in the upper right corner of TI display).
- (77) Press TI **REFERENCE LEVEL, 50**, and **-dBm** keys.
- (78) Set attenuator No. 2 to 40 dB.
- (79) Adjust A4A5R44 (fig. 15) for a TI **MKR Δ LVL** of .00 dB (**MKR Δ LVL** indication is now in the upper right corner of TI display).
- (80) Press TI **REFERENCE LEVEL, 70**, and **-dBm** keys.
- (81) Set attenuator No. 2 to 60 dB.
- (82) Adjust A4A5R54 (fig. 15) for a TI **MKR Δ LVL** of .00 dB (**MKR Δ LVL** indication is now in the upper right corner of TI display).
- (83) Press TI keys as listed in (a) through (c) below:
- (a) **REFERENCE LEVEL, 19.9, -dBm.**
 - (b) **MARKER Δ .**
 - (c) **MARKER Δ .**
- (84) Set attenuator No. 2 to 10 dB.
- (85) Press TI **REFERENCE LEVEL, 17.9**, and **-dBm** keys.
- (86) Set attenuator No. 1 to 3 dB and attenuator No. 2 to 10 dB.
- (87) TI **MKR Δ LVL** as indicated by TI annotation should be $.00 \pm 0.5$ dB.
- (88) Press TI **REFERENCE LEVEL, 15.9**, and **-dBm** keys.
- (89) Set attenuator No 1 to 1 dB.

- (90) TI **MKR Δ LVL** as indicated by TI annotation should be $.00 \pm 0.5$ dB.
- (91) Press TI **REFERENCE LEVEL, 11.9**, and **-dBm** keys.
- (92) Set attenuator No. 2 to 0 and attenuator No. 1 to 7 dB.
- (93) TI **MKR Δ LVL** as indicated by TI annotation should be $.00 \pm 0.5$ dB.
- (94) Press TI keys as listed in (a) through (d) below:
 - (a) **SCALE LIN.**
 - (b) **SHIFT.**
 - (c) **AUTO^A.**
 - (d) **REFERENCE LEVEL, 19.9, -dBm.**
- (95) Set attenuators as in step (86) above.
- (96) Press TI keys as listed in (a) through (c) below:
 - (a) **MARKER Δ.**
 - (b) **MARKER Δ.**
 - (c) **REFERENCE LEVEL, 18, and -dBm.**
- (97) Set attenuators as in step (89) above.
- (98) Adjust A4A5R51 (fig. 15) for a TI **MKR Δ LVL** indication of -0.10 dB (R).
- (99) Remove attenuators from hookup.
- (100) Connect TI **CAL OUTPUT** to TI **RF INPUT**.
- (101) Press TI keys as listed in (a) and (b) below:
 - (a) **2-22 GHz.**
 - (b) **RECALL, 9.**
- (102) Set TI **FREQ ZERO** control to midrange.
- (103) Adjust A4A5C10 (fig. 15) to peak signal trace on TI.
- (104) Press TI keys as listed in (a) through (d) below:
 - (a) **FREQUENCY SPAN, 500, Hz.**
 - (b) **RES BW, 100, Hz.**
 - (c) **MARKER PEAK SEARCH.**
 - (d) **MARKER Δ.**
- (105) Adjust TI **FREQ ZERO** control fully clockwise.
- (106) Press TI **MARKER PEAK SEARCH** key.
- (107) Signal peak should be at least 60 Hz away from center graticule.
- (108) Press TI keys as listed in (a) and (b) below:
 - (a) **2-22 GHz.**
 - (b) **RECALL, 9.**
- (109) Set TI **FREQ ZERO** control to peak signal trace on TI.
- (110) Press TI **2-22 GHz** key.

16. Scale Fidelity

a. Performance Check

- (1) Press TI **2-22 GHz**.
- (2) Connect equipment as shown in fig. 26.

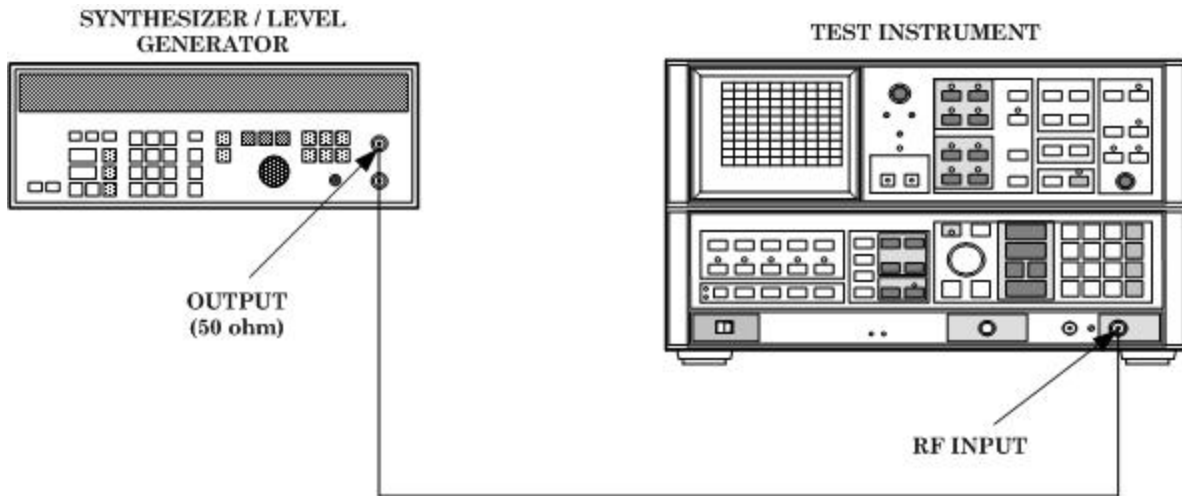

Figure 26. Scale fidelity connection.

- (3) Set synthesizer/level generator for an output frequency of 20.000 MHz, an output power level of +10 dBm, and amplitude increments of 10 dB/step.
- (4) Press TI keys as listed in (a) through (f) below:
 - (a) **CENTER FREQUENCY, 20, MHz.**
 - (b) **FREQUENCY SPAN, 50, kHz.**
 - (c) **REFERENCE LEVEL, 10, +dBm.**
 - (d) **MARKER PEAK SEARCH.**
 - (e) **MKR→CF.**
 - (f) **MKR→REF LVL.**
- (5) Press TI keys as listed in (a) through (c) below:
 - (a) **FREQUENCY SPAN, 0, Hz.**
 - (b) **VIDEO BW, 1, Hz.**
 - (c) **MARKER Δ.**
- (6) If TI marker Δ amplitude displayed is not within limits specified in first row of table 15, perform **b** below.
- (7) Step synthesizer/level generator output down 10 dB.
- (8) Repeat technique in steps (6) and (7) above for remaining synthesizer/level generator output settings listed in table 15. If TI marker Δ amplitudes displayed are not within limits specified in table 15, perform **b** below.

Table 15. Scale Fidelity

Synthesized/level generator Output amplitude (dBm)	Test instrument	
	Marker Δ amplitude readout	
	Min	Max
+10	0	0
0	-11	-9
-10	-21	-19
-20	-31	-29
-30	-41	-39
-40	-51	-49
-50	-61	-59
-60	-71	-69
-70	-81	-79
-80	-91.5	-88.5

- (9) Press TI keys as listed in (a) through (c) below:
 - (a) **VIDEO BW, 300, Hz.**
 - (b) **FREQUENCY SPAN, 1, MHz.**
 - (c) **RES BW, 1, MHz.**
- (10) Set synthesizer/level generator output amplitude to +10 dBm.
- (11) Press TI keys as listed in (a) through (g) below:
 - (a) **SCALE LIN.**
 - (b) **MARKER PEAK SEARCH.**
 - (c) **MARKER \rightarrow CF.**
 - (d) **FREQUENCY SPAN, 0, Hz.**
 - (e) **VIDEO BW, 1, Hz.**
 - (f) **SHIFT, AUTO^A.**
 - (g) **MARKER Δ .**

(12) Step synthesizer/level generator output down 10 dB. If TI marker Δ amplitude displayed is not within limits specified in first row of table 16, perform **b** below.

(13) Repeat technique in step (11) and (12) above for remaining synthesizer/level generator output settings listed in table 16. If TI marker Δ amplitude indications displayed are not within limits specified in table 16, perform **b** below.

Table 16. Linear Fidelity

Synthesizer/level generator Output amplitude (dBm)	Test instrument	
	Marker Δ amplitude readout	
	Min	Max
+10	0	0
0	-10.87	-9.21
-10	-23.10	-17.72

b. Adjustments.

- (1) Disconnect synthesizer/level generator **50 Ω OUTPUT** from TI **RF INPUT**.
- (2) Set TI **LINE** switch to **STANDBY**.

- (3) Remove TI top cover.
- (4) Remove cables attached to the A3 digital storage cage.
- (5) Remove A3 digital storage cage cover.
- (6) Reconnect cables removed in (4) above.
- (7) Set TI **LINE** switch to **ON**.
- (8) Press TI keys as listed in (a) through (f) below:
 - (a) **2-22 GHz**.
 - (b) **CENTER FREQUENCY, 7.6, MHz**.
 - (c) **FREQUENCY SPAN, 0, Hz**.
 - (d) **REFERENCE LEVEL, 10, +dBm**.
 - (e) **RES BW, 10, kHz**.
 - (f) **SCALE LIN**.
- (9) Connect multimeter **HI** to A4A1TP1 (fig. 21) and multimeter **LO** to A3A9TP1 (fig. 22).
- (10) Adjust A4A2R79 (fig. 24) for 0.0000 ± 0.0005 Vdc.
- (11) Press TI **SCALE LOG** key.
- (12) Connect TI **RF INPUT** to synthesizer/level generator **50Ω OUTPUT**.
- (13) Set synthesizer/level generator for an output frequency of 7.6 MHz at an output level of 5 dBm.
- (14) Adjust A4A3C55 (fig. 25) for a maximum multimeter indication.

NOTE

If A4A3C55 is at an extreme of its adjustment range (fully meshed or unmeshed) then TI must be repaired.

- (15) Short A4A3TP7 to A4A3TP8 (fig. 25) and record multimeter indication.
- (16) Remove short from between A4A3TP7 and A4A3TP8 (fig. 25).
- (17) Adjust A4A3R67 (fig. 25) for a multimeter indication the same as that recorded in (15) above ± 0.0005 V dc (R). If TI cannot be adjusted to meet this tolerance then TI must be repaired.
- (18) Press TI **SCALE LIN** key.
- (19) Adjust synthesizer/level generator output level for a multimeter indication of 1.000 ± 0.002 V dc.
- (20) Press TI **SCALE LOG** key.
- (21) Decrease synthesizer/level generator output level by 50 dBm.
- (22) Adjust A4A2R91 (fig. 24) for a multimeter indication of 0.500 ± 0.001 V dc (R).
- (23) Increase synthesizer/level generator output level by 50 dBm.
- (24) Adjust A4A2R61 (fig. 24) for a multimeter indication of 1.000 ± 0.001 V dc (R). If TI cannot be adjusted to meet this tolerance then TI must be repaired.
- (25) Press TI **SCALE LIN** key.

(26) Multimeter should indicate 1.000 ± 0.020 V dc. If multimeter indication is out of tolerance then TI must be repaired.

(27) Press TI **REFERENCE LEVEL, 0**, and **dBm** keys.

(28) Adjust synthesizer/level generator output level for a multimeter indication of 1.000 ± 0.001 V dc.

(29) Press TI keys as listed in (a) through (c) below:

(a) **SHIFT.**

(b) **SCALE LOG.**

(c) **REFERENCE LEVEL, 60, -dBm.**

(30) Decrease synthesizer/level generator output level by 10 dBm.

(31) Adjust A4A3R83 (fig. 25) for a multimeter indication of 1.000 ± 0.010 V dc. If multimeter indication is out of tolerance then TI must be repaired.

(32) Press TI **REFERENCE LEVEL, 70**, and **-dBm** keys.

(33) Decrease synthesizer/level generator output level by 10 dBm.

(34) Adjust A4A2R14 (fig. 24) for a multimeter indication of 1.000 ± 0.010 V dc. If multimeter indication is out of tolerance then TI must be repaired.

(35) Press TI **2-22 GHz** key.

17. Frequency Response

a. Performance Check

(1) Connect TI **CAL OUTPUT** to TI **RF INPUT**.

(2) Press TI keys as listed in (a) through (c) below:

(a) **2-22 GHz.**

(b) **RECALL, 8.**

(c) **MARKER PEAK SEARCH.**

(3) Adjust TI **AMPTD CAL** for a marker amplitude indication of -10.00 ± 0.02 dBm on TI display.

(4) Disconnect TI **CAL OUTPUT** from TI **RF INPUT**.

(5) Connect TI **RF INPUT** to function/arbitrary generator **SIGNAL OUTPUT**.

(6) Press TI keys as listed in (a) through (c) below:

(a) **2-22 GHz.**

(b) **START FREQ, 20, kHz.**

(c) **STOP FREQ, 1, MHz.**

(7) Set function/arbitrary generator for a sine wave output of 510.0 kHz at an amplitude of 0 dBm.

(8) Adjust function/arbitrary generator output amplitude to place the signal peak on the top graticule line of the TI display.

(9) Press TI **LOG ENTER dB/DIV, 1**, and **dB** keys.

(10) Adjust function/arbitrary generator output amplitude to place the signal peak 2 divisions down from the top graticule line of the TI display. Do not readjust amplitude during test.

(11) Press TI **TRACE A MAX HOLD** key.

(12) Set function/arbitrary generator for a single sweep with a 1 Hz start frequency, 1 MHz stop frequency, and 99.9 second sweep time.

(13) Start sweep and when sweep is completed press TI **TRACE A VIEW** key.

(14) Press TI keys as listed in (a) and (b) below:

(a) **MARKER PEAK SEARCH.**

(b) **MARKER Δ.**

(15) Adjust TI **DATA** knob to scroll Δ marker across displayed trace while observing marker Δ amplitude indication on TI display.

(16) TI marker Δ amplitude deviation will be within limits specified in table 17.

Table 17. Frequency Response (100 Hz to 100 kHz)

Test instrument	
Displayed amplitude (dB)	
Min	Max
0	1.2

(17) Press TI keys as listed in (a) through (g) below:

(a) **0 – 2.5 GHz.**

(b) **CENTER FREQUENCY, 4, MHz.**

(c) **FREQUENCY SPAN, 2, MHz.**

(d) **RES BW, 300, kHz.**

(e) **LOG dB/DIV, 1, dB.**

(f) **RES BW, 30, kHz.**

(g) **SWEEP CONT.**

(h) **MARKER OFF.**

(18) Set function/arbitrary generator for an output of 40.5 MHz at an amplitude of -2 dBm.

(19) Adjust function/arbitrary generator output to place the signal peak 2 divisions down from the top graticule line of TI display.

(20) Press TI keys as listed in (a) and (b) below:

(a) **START FREQ, 1, MHz.**

(b) **STOP FREQ, 80, MHz.**

(21) Change function/arbitrary generator output frequency to 39.5 MHz with a sweep width of 79,900,000 Hz and sweep from 1 MHz to 80 MHz.

(22) Press TI keys as listed in (a) and (b) below:

(a) **TRACE A CLEAR-WRITE.**

(b) **MAX HOLD.**

(23) Start a 50 second single sweep of the function/arbitrary generator and wait for completion of the sweep.

(24) Press TI **MARKER NORMAL** and adjust the TI **DATA** knob to move the marker to the highest and lowest points of displayed amplitude. The amplitude deviation will be within limits specified in table 18.

Table 18. Frequency Response (100 kHz to 80 MHz)

Test instrument	
Displayed amplitude (dB)	
Min	Max
0	1.2

(25) Disconnect TI **RF INPUT** from function/arbitrary generator **SIGNAL OUTPUT**.

(26) Connect measuring receiver sensor module to measuring receiver power reference output.

(27) Zero and calibrate the sensor module.

(28) Connect equipment as shown in fig. 27.

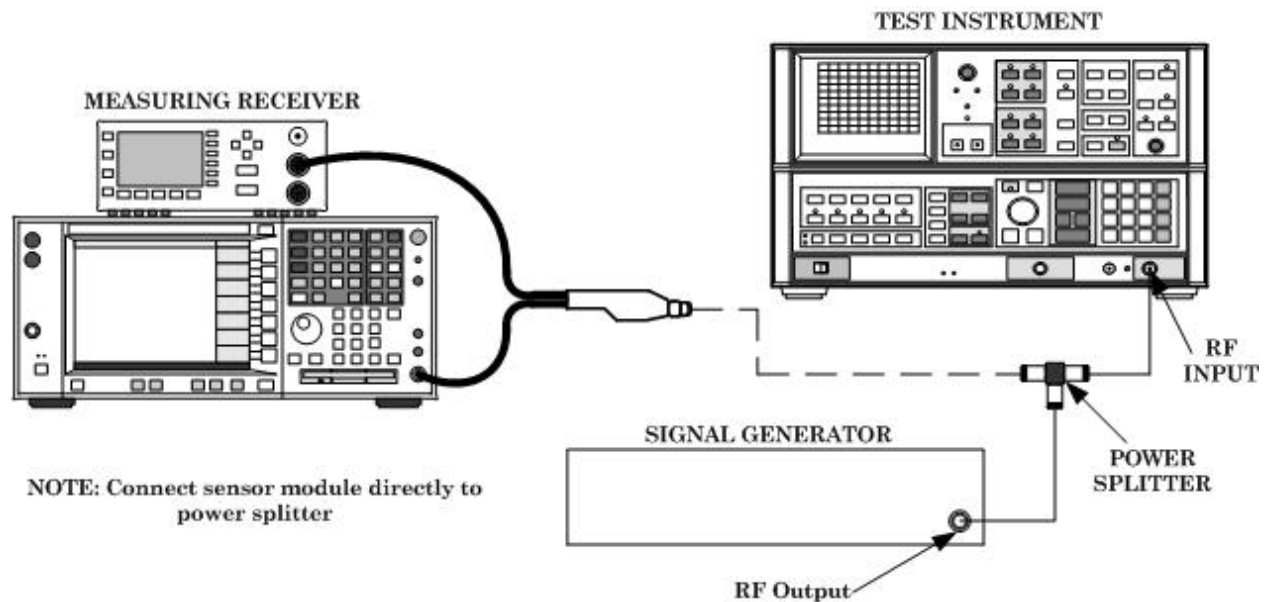

Figure 27. Frequency response connection 1.

(29) Press TI keys as listed in (a) through (f) below:

- (a) **0-2.5GHz.**
- (b) **TRACE A CLEAR-WRITE.**
- (c) **CENTER FREQUENCY, 100, MHz.**
- (d) **FREQUENCY SPAN, 10, MHz.**
- (e) **SWEEP CONT.**
- (f) **LOG dB/DIV, 1, dB.**

(30) Set signal generator frequency to 100 MHz and level output to 4 dBm.

(31) Set up measuring receiver to measure power at 100 MHz.

(32) Adjust signal generator RF output level for a measuring receiver indication of -2.0 ± 0.1 dBm.

(33) Press TI **MARKER PEAK SEARCH** key. The amplitude displayed will be within limits specified in the first row table 19.

(34) Repeat the technique of (29) through (32) above for remaining settings in table 19. The amplitude displayed will be within limits specified in table 19.

Table 19. Frequency Response (100 MHz to 2 GHz)

Signal generator		Test instrument			
Frequency	Adjusted output level	Center frequency	Span	Readout amplitude (dBm)	
				Min	Max
100 MHz	-2 dBm	100 MHz	10 MHz	-2.6	-1.4
400 MHz	-2 dBm	400 MHz	10 MHz	-2.6	-1.4
1 GHz	-2 dBm	1 GHz	10 MHz	-2.6	-1.4
2 GHz	-2 dBm	2 GHz	10 MHz	-2.6	-1.4

(35) Disconnect signal generator RF output connector from the power splitter input.

(36) Connect equipment as shown in figure 28.

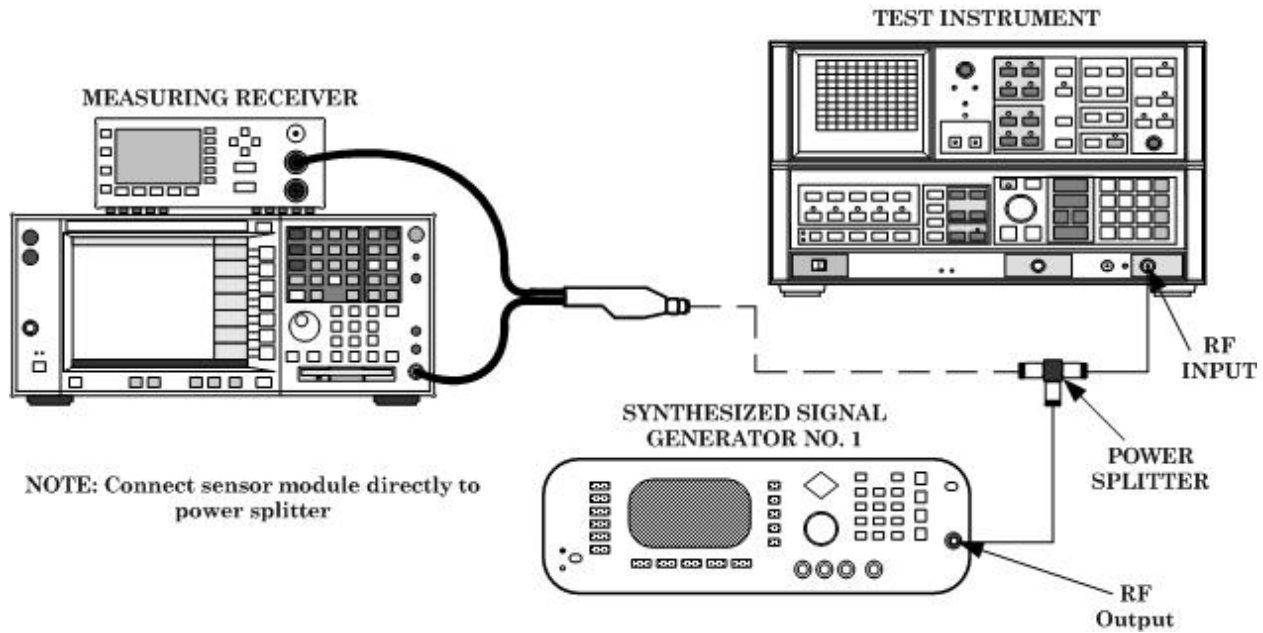

Figure 28. Frequency response connection 2.

(37) Press TI keys as listed in (a) and (b) below:

(a) **CENTER FREQ, 2.4, GHz.**

(b) **SPAN, 10 MHz.**

(38) Set synthesized signal generator No. 1 frequency to 2.4 GHz and level output to 4 dBm.

(39) Set up measuring receiver to measure power at 2.4 GHz.

(40) Adjust synthesized signal generator No. 1 **RF Output** level for a measuring receiver indication of -2.0 ± 0.1 dBm.

(41) Press TI **MARKER PEAK SEARCH**. The amplitude displayed will be within limits specified in table 20.

Table 20. Frequency Response (2.4 GHz)

Signal generator No. 2	Test instrument			
	Center frequency	Frequency span	Readout amplitude (dBm)	
Min			Max	
2.4 GHz	2.4 GHz	10 MHz	-2.6	-1.4

(42) Press TI keys as listed in (a) through (c) below:

- (a) **2-22 GHz**
- (b) **CENTER FREQ, 4.0, GHz.**
- (c) **SPAN, 10 MHz.**

(43) Set synthesized signal generator No. 1 frequency to 4 GHz and level output to 4 dBm.

(44) Set up measuring receiver to measure power at 4 GHz and adjust synthesized signal generator No. 1 **RF OUTPUT** level for a measuring receiver indication of -2.0 ± 0.1 dBm.

(45) Press TI **MARKER PEAK SEARCH**. The amplitude displayed will be within limits specified in the first row of table 21.

(46) Repeat the technique of (42) (b) through (45) above for remaining settings in table 21. The amplitude displayed will be within limits specified in table 21.

Table 21. Frequency Response (4.0 GHz to 18 GHz)

Synthesized signal generator No. 1	Test instrument			
	Center frequency	Frequency span	Readout amplitude (dBm)	
Min			Max	
4.0 GHz	4.0 GHz	10 MHz	-3.7	-0.3
7.0 GHz	7.0 GHz	100 MHz	-3.7	-0.3
10.0 GHz	10.0 GHz	100 MHz	-3.7	-0.3
13.5 GHz	13.5 GHz	100 MHz	-4.2	+0.2
15.0 GHz	15.0 GHz	100 MHz	-4.2	+0.2
17.0 GHz	17.0 GHz	100 MHz	-4.2	+0.2
18.0 GHz	18.0 GHz	100 MHz	-4.2	+0.2

b. Adjustments. No adjustments can be made.

18. Sweep Time Accuracy

a. Performance Check

- (1) Connect TI **PENLIFT OUTPUT** (rear panel) to electronic counter **A** input.
- (2) Set up electronic counter as indicated in (a) through (j) below:
 - (a) **STANDBY/ON** to **ON**.
 - (b) **FUNCTION** to **TIME A/B**.
 - (c) **INPUT B** to **COM A**.
 - (d) **INPUT A** slope to negative.

- (e) **INPUT B** slope to positive.
 - (f) **INPUT A, AC/DC** to **DC**.
 - (g) **INPUT A, 50Ω/1MΩ** to **1MΩ**.
 - (h) **TRIGGER LEVEL** set **A** to **0.7 V**.
 - (i) **INPUT A, 1X/10X** to **10X**.
 - (j) **HOLD OFF** to **ON**.
- (3) Press TI keys as listed in (a) through (d) below:
- (a) **2-22 GHz**.
 - (b) **CENTER FREQ, 500 MHz**.
 - (c) **SPAN, 0 Hz**.
 - (d) **SWEEP TIME, 20, mSEC**.
- (4) Electronic counter will indicate within limits specified in first row of table 22.
- (5) Repeat (3) (d) and (4) above for remaining sweep time settings in table 22. Electronic counter will indicate within limits specified in table 22.

Table 22. Sweep Time Accuracy

Test instrument sweep time	Electronic counter displayed reading	
	Min	Max
20 ms	18 ms	22 ms
30 ms	27 ms	33 ms
50 ms	45 ms	55 ms
70 ms	63 ms	77 ms
90 ms	81 ms	99 ms
110 ms	99 ms	121 ms
170 ms	153 ms	187 ms
200 ms	180 ms	220 ms
2 s	1.8 s	2.2 s

- (6) Set electronic counter for a gate time of 10 sec.
- (7) Press TI **MARKER NORMAL** key.
- (8) Use TI ↓ key to place marker at second vertical graticule line.
- (9) Press TI **SWEEP TIME, 20,** and **SEC** keys.
- (10) Press electronic counter **MEASUREMENT RESTART**.
- (11) Press TI **TRACE A CLEAR-WRITE** key and allow TI to complete sweep.
- (12) Electronic counter will indicate within limits specified in first row of table 23.
- (13) Repeat (9) through (11) above for remaining sweep time setting in table 23. Electronic counter will indicate within limits specified in table 23.

Table 23. Sweep Time Accuracy

Test instrument Sweep time	Electronic counter displayed reading	
	Min	Max
20 s	18 s	22 s
200 s	188 s	222 s

b. Adjustments. None.

19. Line Related Sidebands

a. Performance Check

- (1) Connect TI **CAL OUTPUT** to TI **RF INPUT**.
- (2) Press TI **2-22 GHz, RECALL, 9**.
- (3) Adjust TI **FREQ ZERO** for a maximum amplitude trace.
- (4) Press TI keys as listed in (a) through (c) below:
 - (a) **2-22 GHz**.
 - (b) **CENTER FREQUENCY, 100, MHz**.
 - (c) **FREQUENCY SPAN, 1.2, kHz**.
- (5) Wait for asterisk in upper right corner of TI display to disappear.
- (6) Press TI keys as listed in (a) through (c) below:
 - (a) **MARKER PEAK SEARCH**.
 - (b) **MKR→CF**.
 - (c) **MKR→REF LVL**.
- (7) Wait for asterisk in upper right corner of TI display to disappear. Trace should be centered on display.
- (8) Press TI keys as listed in (a) and (b) below:
 - (a) **SHIFT, VIDEO BW^G**.
 - (b) **SWEEP SINGLE, 10, Hz**.
- (9) When TI display **VID AVG** readout is **10**, press TI keys as listed in (a) through (e) below:
 - (a) **SHIFT**.
 - (b) **TRACE B BLANK**.
 - (c) **TRACE A VIEW**.
 - (d) **MARKER PEAK SEARCH**.
 - (e) **MARKER Δ**.
- (10) Adjust TI **DATA** knob to move the **Δ MARKER** to the point on the displayed trace at which the **Δ** marker frequency indication is **-120 Hz**.
- (11) TI marker **Δ** amplitude will indicate within limits specified in first row of table 24.
- (12) Repeat technique of (10) and (11) above for remaining marker **Δ** settings in table 24. TI marker **Δ** amplitude displayed will indicate within limits specified in table 24.

Table 24. Line Related Sidebands

Test instrument		
Line sideband (Hz)	Marker Δ amplitude displayed (dB)	
	Min	Max
-120	-100	-70
-180	-100	-70
-240	-100	-70

Table 24. Line Related Sidebands - Continued

Line sideband (Hz)	Test instrument	
	Marker Δ amplitude displayed (dB)	
	Min	Max
-300	-100	-70
-360	-100	-75
-420	-100	-75
-480	-100	-75
-540	-100	-75
120	-100	-70
180	-100	-70
240	-100	-70
300	-100	-70
360	-100	-75
420	-100	-75
480	-100	-75
540	-100	-75

b. Adjustments. None.

20. Average Noise Level

a. Performance Check

- (1) Connect TI **CAL OUTPUT** to TI **RF INPUT**.
- (2) Press TI **2-22 GHz**, **RECALL**, **8**.
- (3) Adjust TI **AMPTD CAL** for a marker amplitude indication of -10.00 ± 0.02 dB on TI display.
- (4) Disconnect TI **CAL OUTPUT** from TI **RF INPUT**.
- (5) Connect 50 Ω , 20 W dummy load to TI **RF INPUT**.
- (6) Press TI keys as listed in (a) through (g) below:
 - (a) **0-2.5 GHz**.
 - (b) **START FREQ, 80, Hz**.
 - (c) **STOP FREQ, 180, Hz**.
 - (d) **REFERENCE LEVEL, 70, -dBm**.
 - (e) **ATTEN, 0, dBm**.
 - (f) **VIDEO BW, 3, Hz**.
 - (g) **SHIFT, VIDEO BW^G**.
- (7) Wait until TI display **VID AVG** readout reaches **15**, and then press TI keys as listed in (a) through (c) below:
 - (a) **SHIFT**.
 - (b) **TRACE B BLANK**.
 - (c) **MARKER NORMAL**.
- (8) Tune TI to 100 Hz reading on TI display.
- (9) Read the amplitude indicated on TI display. Amplitude indicated will be within limits specified in table 25.

Table 25. Average Noise Level

Test instrument	
Center frequency	Displayed amplitude limit (dBm)
100 Hz	≤ -95

(10) Press TI keys as listed in (a) through (c) below:

- (a) **CENTER FREQUENCY, 51, kHz.**
- (b) **FREQUENCY SPAN, 0, Hz.**
- (c) **SWEEP TIME, 20, mSEC.**

(11) Wait until TI display **VID AVG** readout reaches >**20**.

(12) Read the amplitude indicated on TI display. Amplitude indicated will be within limits specified in the first row of table 26.

(13) Repeat technique of (10) (a), (11) and (12) above for remaining **CENTER FREQUENCY** settings in table 26. TI amplitude displayed will indicate within limits specified in table 26.

Table 26. Average Noise Level

Test instrument	
Center frequency	Displayed amplitude limit (dBm)
51 kHz	≤ -112
2.0 MHz	≤ -134
1.0 GHz	≤ -134
2.499 GHz	≤ -134
2.510 GHz	≤ -132
5.799 GHz	≤ -132
5.810 GHz	≤ -125
12.499 GHz	≤ -125
12.510 GHz	≤ -119
18 GHz	≤ -119

b. Adjustments. None.

21. Residual Response

a. Performance Check

- (1) Press TI **2-22 GHz** key.
- (2) Connect TI **CAL OUTPUT** to TI **RF INPUT**.
- (3) Press TI **RECALL**, and 8 keys.
- (4) Adjust TI **AMPTD CAL** for a marker amplitude indication of -10.00 ± 0.02 dB on TI display.
- (5) Disconnect TI **CAL OUTPUT** from TI **RF INPUT**.
- (6) Connect 50 Ω, 20 W dummy load to TI **RF INPUT**.
- (7) Press TI keys as listed in (a) through (h) below:
 - (a) **0-2.5 GHz.**

- (b) **REFERENCE LEVEL, 20, -dBm.**
- (c) **ATTEN, 0, dBm.**
- (d) **RES BW, 10, kHz.**
- (e) **VIDEO BW, 1, kHz.**
- (f) **START FREQ, 100, Hz**
- (g) **STOP FREQ, 1.5, GHz.**
- (h) **DISPLAY LINE ENTER, 100, -dBm.**

NOTE

Throughout the residual response parameter there should be at least a 3 dB margin between the noise trace and the display line so that any residual response may be distinguished from the noise. It may be necessary to reduce the resolution and/or video bandwidths from the settings given to achieve this margin.

- (8) Press TI keys as listed in (a) and (b) below:
 - (a) **TRACE A CLEAR WRITE.**
 - (b) **SWEEP SINGLE.**
- (9) Wait for completion of sweep.
- (10) Press TI **MARKER PEAK SEARCH10** key.
- (11) Amplitude indicated on TI display will be within limits specified in the first row of table 27.
- (12) Repeat technique used in (7) (d) through (g) and (8) through (11) above for remaining TI settings in table 27. TI amplitude displayed will indicate within limits specified in table 27.

Table 27. Residual Response (100 Hz to 5.8 GHz)

Test Instrument				
Start frequency	Stop frequency	Resolution bandwidth	Video bandwidth	Displayed amplitude limit (dBm)
100 Hz	1.5 GHz	10 kHz	1 kHz	< -100 dBm
1.4 GHz	2.5 GHz	10 kHz	1 kHz	< -100 dBm
2.4 GHz	5.8 GHz	3 kHz	3 kHz	< -100 dBm

- (13) Press TI keys as listed in (a) through (h) below:
 - (a) **MARKER OFF.**
 - (b) **DISPLAY LINE ENTER, 95, -dBm.**
 - (c) **CENTER FREQUENCY, 6.2, GHz.**
 - (d) **CF STEP SIZE, 990, MHz.**
 - (e) **FREQUENCY SPAN, 1, GHz.**
 - (f) **VIDEO BW, 1, kHz.**
 - (g) **TRACE A CLEAR-WRITE.**
 - (h) **SWEEP SINGLE.**
- (14) Wait for completion of sweep.
- (15) Press TI **MARKER PEAK SEARCH** key.

(16) Amplitude indicated on TI display will be within limits specified in the first row of table 28.

(17) Press TI keys as listed in (a) and (b) below:

- (a) **CENTER FREQUENCY.**
- (b) **↑.**

(18) Repeat technique used in (13) (c) and (14) through (17) above for remaining TI settings in table 28. TI amplitude indicated will be within limits specified in table 28.

Table 28. Residual Response (5.7 GHz to 11.65 GHz)

Test instrument	
Center frequency (GHz)	Displayed amplitude limit (dBm)
6.2	< -95
7.19	< -95
8.18	< -95
9.17	< -95
10.16	< -95
11.15	< -95

(19) Press TI keys as listed in (a) through (e) below:

- (a) **START FREQUENCY, 11.6, GHz.**
- (b) **STOP FREQUENCY, 12.5, GHz.**
- (c) **VIDEO BW, 3, kHz.**
- (d) **TRACE A CLEAR WRITE.**
- (e) **SWEEP SINGLE.**

(20) Wait for completion of sweep.

(21) Press TI **MARKER PEAK SEARCH** key.

(22) Amplitude indicated on TI display will be within limits specified in table 29.

Table 29. Residual Response (11.6 GHz to 12.5 GHz)

Test Instrument		
Start frequency	Stop frequency	Displayed amplitude limit (dBm)
11.6 GHz	12.5 GHz	< -95

(23) Press TI keys as listed in (a) through (g) below:

- (a) **START FREQUENCY, 12.4, GHz.**
- (b) **STOP FREQUENCY, 18.0, GHz.**
- (c) **RES BW, 100, kHz.**
- (d) **VIDEO BW, 3, kHz.**
- (e) **DISPLAY LINE ENTER, 85, -dBm.**
- (f) **TRACE A CLEAR WRITE.**
- (g) **SWEEP SINGLE.**

(24) Wait for completion of sweep.

(25) Press TI **MARKER PEAK SEARCH** key.

(26) Amplitude indicated on TI display will be within limits specified in table 30.

Table 30. Residual Response (12.4 GHz to 18.0 GHz)

Test instrument		
Start frequency	Stop frequency	Displayed amplitude limit (dBm)
12.4 GHz	18.0 GHz	<-85

b. Adjustments. None.

22. Harmonic Distortion

a. Performance Check

- (1) Press TI keys as listed in (a) through (d) below:
 - (a) **2-22 GHz.**
 - (b) **CENTER FREQUENCY, 230, MHz.**
 - (c) **SPAN, 100, kHz.**
 - (d) **REFERENCE LEVEL, 30, -dBm.**
- (2) Connect signal generator RF output connector to one end of the 250 MHz low pass filter.
- (3) Connect TI **10 MHz OUT** (rear panel) to signal generator external reference in connector (rear panel).
- (4) Connect TI **RF INPUT** to the other end of the 250 MHz low pass filter.
- (5) Set up signal generator for an output frequency of 230 MHz at an output level of -30 dBm.
- (6) Adjust signal generator output level to position the trace at reference level (top) graticule line.
- (7) Press TI keys as listed in (a) through (i) below:
 - (a) **DISPLAY LINE ENTER, 110, -dBm.**
 - (b) **MARKER PEAK SEARCH.**
 - (c) **MARKER→CF.**
 - (d) **MARKER/Δ→STEP SIZE.**
 - (e) **CENTER FREQUENCY.**
 - (f) **↑.**
 - (g) **FREQUENCY SPAN, 10, kHz.**
 - (h) **VIDEO BW, 30, Hz.**
 - (i) **RES BW, 30 Hz.**
- (8) Wait for * on TI display to disappear.
- (9) Press TI **MARKER PEAK SEARCH** key.
- (10) Amplitude indicated on TI display will be within limits specified in table 31.

Table 31. Harmonic Distortion (230 MHz)

Test instrument		
Center frequency	Displayed harmonic	Displayed amplitude limit (dBm)
230 MHz	Second	< -110

- (11) Replace the 250 MHz low pass filter with the 1200 MHz low pass filter.
- (12) Press TI keys as listed in (a) through (d) below:
 - (a) **2-22 GHz.**
 - (b) **CENTER FREQUENCY, 800, MHz.**
 - (c) **SPAN, 100, kHz.**
 - (d) **REFERENCE LEVEL, 30, -dBm.**
- (13) Set up signal generator for an output frequency of 800 MHz at an output level of -30 dBm.
- (14) Adjust signal generator output level to position the trace at reference level (top) graticule line.
- (15) Press TI keys as listed in (a) through (h) below:
 - (a) **DISPLAY LINE ENTER, 100, -dBm.**
 - (b) **MARKER PEAK SEARCH.**
 - (c) **MARKER→CF.**
 - (d) **MARKER/Δ→STEP SIZE.**
 - (e) **CENTER FREQUENCY, ↑.**
 - (f) **FREQUENCY SPAN, 10, kHz.**
 - (g) **VIDEO BW, 30, Hz.**
 - (h) **RES BW, 30 Hz.**
- (16) Wait for * on TI display to disappear.
- (17) Press TI **MARKER PEAK SEARCH** key.
- (18) Amplitude indicated on TI display will be within limits specified in table 32.

Table 32. Harmonic Distortion (800 MHz)

Test Instrument		
Center frequency	Displayed harmonic	Displayed amplitude limit (dBm)
800 MHz	Second	< -100

- (19) Disconnect signal generator RF output connector from the test setup.
- (20) Disconnect TI **10 MHz OUT** (rear panel) from signal generator external reference in connector (rear panel).
- (21) Connect synthesized signal generator No. 1 **RF Output** to one end of the 8 GHz low-pass filter.
- (22) Connect TI **10 MHz OUT** (rear panel) to synthesized signal generator No. 1 **10 MHz REF IN** (rear panel).
- (23) Connect TI **RF INPUT** to the other end of the 8 GHz low-pass filter.
- (24) Press TI keys as listed in (a) through (d) below:
 - (a) **2-22 GHz.**
 - (b) **CENTER FREQUENCY, 7.2, GHz.**
 - (c) **FREQUENCY SPAN, 100, kHz.**
 - (d) **REFERENCE LEVEL, 0, dBm.**

(25) Set up synthesized signal generator No. 1 for an output frequency of 7.2 GHz at an output level of 0 dBm.

(26) Adjust synthesized signal generator No. 1 output level to position the trace at reference level (top) graticule line.

(27) Press TI keys as listed in (a) through (g) below:

- (a) **MARKER PEAK SEARCH.**
- (b) **MARKER→CF.**
- (c) **MARKER/Δ→STEP SIZE.**
- (d) **CENTER FREQUENCY, ↑.**
- (e) **FREQUENCY SPAN, 1, kHz.**
- (f) **REFERENCE LEVEL, 20, -dBm.**
- (g) **DISPLAY LINE ENTER, 80, -dBm.**

(28) Wait for * on TI display to disappear.

(29) Press TI **MARKER PEAK SEARCH** key

(30) Amplitude indicated on TI display will be within limits specified in table 33.

Table 33. Harmonic Distortion (7.2 GHz)

Test instrument		
Center frequency	Displayed harmonic	Displayed amplitude limit (dBm)
7.2 GHz	Second	< -100

(31) Press TI **2-22 GHz** key.

(32) Connect equipment as shown in figure 29.

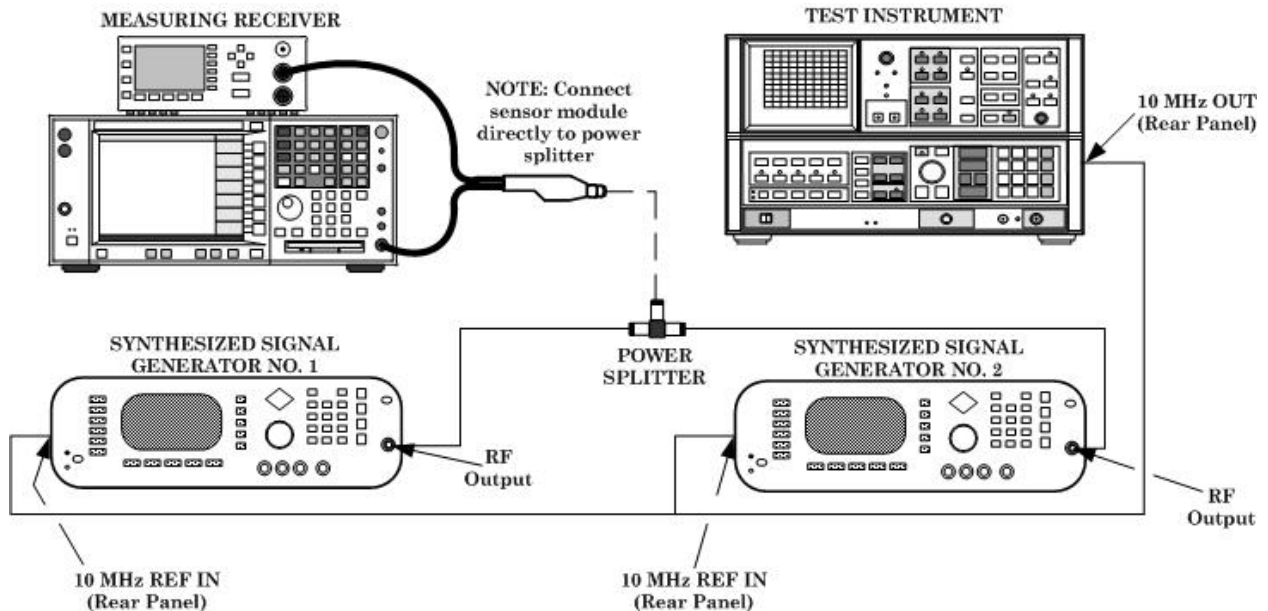

Figure 29. Harmonic distortion setup.

(33) Set synthesized signal generator No. 2 for an output frequency of 2.0995 GHz at a level of -15 dBm.

- (34) Set up measuring receiver to measure RF power.
- (35) Adjust synthesized signal generator No. 2 output level for a -20 ± 0.2 dBm indication on measuring receiver.
- (36) Set synthesized signal generator No. 2 **RF Output** to off.
- (37) Set synthesized signal generator No. 1 for an output frequency of 2.1005 GHz at a level of -15 dBm.
- (38) Set up measuring receiver to measure RF power.
- (39) Adjust synthesized signal generator No. 1 output level for a -20 ± 0.2 dBm indication on measuring receiver.
- (40) Set synthesized signal generator No. 1 **RF Output** to off.
- (41) Disconnect sensor module from power splitter.
- (42) Connect TI **RF INPUT** to the open port of the power splitter.
- (43) Set synthesized signal generator No. 1 and synthesized signal generator No. 2 **RF Output** to on.
- (44) Press TI keys as listed in (a) through (d) below:
 - (a) **CENTER FREQUENCY, 2.0995, GHz.**
 - (b) **CF STEP SIZE, 1, MHz.**
 - (c) **FREQUENCY SPAN, 2, kHz.**
 - (d) **ATTEN, 0, dB.**
- (45) When sweep is complete, press TI **MARKER PEAK SEARCH** and **MKR→CF** keys and wait for completion of the sweep.
- (46) Press TI **MARKER Δ, CENTER FREQUENCY,** and **↓** keys.
- (47) When sweep is complete, press TI **MARKER PEAK SEARCH** key and record the MKR A amplitude in peak search 1 column of table 34.
- (48) Press TI **↑, ↑, ↑** keys and wait for completion of sweep.
- (49) Press TI **MARKER PEAK SEARCH** key and record the MKR A amplitude in peak search 2 column of table 34.
- (50) Choose the smaller of the two values recorded in the peak search columns and record the value (no sign) in Absolute Value column of table 34.
- (51) Calculate the third order intercept using the formula below. Calculated value will be within the limits specified in table 34.

$$\text{Adjusted output level} + \text{absolute value}/2 = \text{third order intercept}$$

Table 34. Third Order Intercept

Synthesized signal generator No. 2		Synthesized signal generator No. 1		Test instrument		Values			
Freq. (GHz)	Adjusted output level (dBm)	Freq. (GHz)	Adjusted output level (dBm)	Center freq. (GHz)	CF step size (MHz)	Peak search 1	Peak search 2	Absolute value	Calculated limit (dB)
2.0995	-20	2.1005	-20	2.0995	1				>7

- (52) Set synthesized signal generator No. 1 and synthesized signal generator No. 2 **RF Output** to off.
- (53) Press **TI MARKER OFF** key.
- (54) Disconnect **TI RF INPUT** from the power splitter.
- (55) Connect sensor module to the open port of the power splitter.
- (56) Set synthesized signal generator No. 2 for an output frequency of 3.9995 GHz at a level of -15 dBm.
- (57) Set up measuring receiver to measure RF power.
- (58) Adjust synthesized signal generator No. 2 output level for a -20 ± 0.2 dBm indication on measuring receiver.
- (59) Set synthesized signal generator No. 2 **RF Output** to off.
- (60) Set synthesized signal generator No. 1 for an output frequency of 4.0005 GHz at a level of -15 dBm.
- (61) Set up measuring receiver to measure RF power.
- (62) Adjust synthesized signal generator No. 1 output level for a -20 ± 0.2 dBm indication on measuring receiver.
- (63) Set synthesized signal generator No. 1 **RF Output** to off.
- (64) Disconnect sensor module from power splitter.
- (65) Connect **TI RF INPUT** to the open port of the power splitter.
- (66) Set synthesized signal generator No. 1 and synthesized signal generator No. 2 **RF Output** to on.
- (67) Press TI keys as listed in (a) through (c) below:
- (a) **CENTER FREQUENCY, 3.9995, GHz.**
 - (b) **CF STEP SIZE, 1, MHz.**
 - (c) **REFERENCE LEVEL, 20, -dBm.**
- (68) Press **TI MARKER OFF** and **MARKER PRESEL PEAK** keys and wait for **(PEAKING!)** on TI to disappear.
- (69) Press **TI MARKER PEAK SEARCH** and **MKR→CF** keys and wait for completion of the sweep.
- (70) Press **TI MARKER Δ**, **CENTER FREQUENCY** and, \downarrow keys.
- (71) When sweep is complete, press **TI MARKER PEAK SEARCH** key and record the MKR A amplitude in peak search 1 column of table 35.
- (72) Press **TI ↑, ↑, ↑** keys and wait for completion of sweep.
- (73) Press **TI MARKER PEAK SEARCH** key and record the MKR A amplitude in peak search 2 column of table 35.
- (74) Choose the smaller of the two values recorded in the peak search columns and record the value (no sign) in absolute value column of table 35.
- (75) Calculate the third order intercept using the formula below. Calculated value will be within the limits specified in the first row of table 35.

$$\text{Adjusted output level} + \text{absolute value}/2 = \text{third order intercept}$$

(76) Repeat technique used in (52) through (75) above for remaining settings in table 35. Calculated values will be within the limits specified in table 35.

Table 35. Third Order Intercept

Synthesized signal generator No. 2		Synthesized signal generator No. 1		Test instrument		Values			
Freq. (GHz)	Adjusted output level (dBm)	Freq. (GHz)	Adjusted output level (dBm)	Center freq. (GHz)	CF Step size (MHz)	Peak search 1	Peak search 2	Absolute value	Calculated limit (dB)
3.9995	-20	4.0005	-20	3.9995	1				>7
8.9995	-20	9.0005	-20	8.9995	1				>5
13.9995	-20	14.0005	-20	13.9995	1				>5

(77) Disconnect equipment setup.

b. Adjustments. None.

23. Out of Band Response

a. Performance Check

- (1) Press TI keys as listed in (a) through (c) below:
 - (a) **2-22 GHz.**
 - (b) **CENTER FREQUENCY, 3, GHz.**
 - (c) **FREQUENCY SPAN, 100, kHz.**
- (2) Connect TI **10 MHz OUT** (rear panel) to synthesized signal generator No. 1 **10 MHz REF IN** (rear panel).
- (3) Connect TI **RF INPUT** to synthesized signal generator No. 1 **RF Output**.
- (4) Set synthesized signal generator No. 1 for an output frequency of 3.0 GHz at an output level of 0 dBm.
- (5) Press TI **MARKER PRESEL PEAK** key and wait for **(PEAKING!)** on TI to disappear.
- (6) Press TI **MARKER OFF** key.
- (7) Adjust synthesized signal generator No. 1 output level to place the peak of the signal trace at the top TI graticule line.
- (8) Press TI keys as listed in (a) through (d) below:
 - (a) **MARKER PEAK SEARCH.**
 - (b) **DISPLAY LINE ENTER, 70, -dBm.**
 - (c) **MARKER Δ.**
 - (d) **SWEEP SINGLE.**
- (9) Change synthesized signal generator No. 1 output frequency to 3.6428 GHz.
- (10) Press TI keys as listed in (a) and (b) below:
 - (a) **SWEEP SINGLE.**
 - (b) **MARKER PEAK SEARCH.**
- (11) The marker Δ amplitude indicated on TI display will be within limits specified in the first row of table 36.

(12) Repeat technique of (9) through (11) above for remaining frequencies listed in table 36. The marker Δ amplitude indicated on TI display will be within limits specified table 36.

Table 36. Out of Band Response (3 GHz)

Synthesized signal generator No. 1	Test instrument
Frequency (GHz)	Displayed amplitude limit (dB)
3.6428	≤ -70
6.3124	≤ -60
6.9642	≤ -60

(13) Press TI keys as listed in (a) through (c) below:

- (a) **SWEEP CONT.**
- (b) **MARKER OFF.**
- (c) **CENTER FREQUENCY, 6, GHz.**

(14) Set synthesized signal generator No. 1 output frequency to 6.0 GHz.

(15) Press TI **MARKER PRESEL PEAK** key and wait for **(PEAKING!)** on TI to disappear.

(16) Press TI **MARKER OFF** key.

(17) Adjust synthesized signal generator No. 1 output level to place the peak of the signal trace at the top TI graticule line.

(18) Press TI keys as listed in (a) through (c) below:

- (a) **MARKER PEAK SEARCH.**
- (b) **MARKER Δ .**
- (c) **SWEEP SINGLE.**

(19) Change synthesized signal generator No. 1 output frequency to 2.5179 GHz.

(20) Press TI keys as listed in (a) and (b) below:

- (a) **SWEEP SINGLE.**
- (b) **MARKER PEAK SEARCH.**

(21) The marker Δ amplitude indicated on TI display will be within limits specified in the first row of table 37.

(22) Repeat technique of (19) through (21) above for remaining frequencies listed in table 37. The marker Δ amplitude indicated on TI display will be within limits specified table 37.

Table 37. Out of Band Response (6 GHz)

Synthesized signal generator No. 1	Test instrument
Frequency (GHz)	Displayed amplitude limit (dB)
2.5179	≤ -60
3.1607	≤ -60
5.3572	≤ -70

(23) Press TI keys as listed in (a) through (c) below:

- (a) **SWEEP CONT.**
 - (b) **MARKER OFF.**
 - (c) **CENTER FREQUENCY, 9, GHz.**
- (24) Set synthesized signal generator No. 1 output frequency to 9.0 GHz.
- (25) Press TI **MARKER PRESEL PEAK** key and wait for **(PEAKING!)** on TI to disappear.
- (26) Press TI **MARKER OFF** key.
- (27) Adjust synthesized signal generator No. 1 output level to place the peak of the signal trace at the top TI graticule line.
- (28) Press TI keys as listed in (a) through (c) below:
- (a) **MARKER PEAK SEARCH.**
 - (b) **MARKER Δ.**
 - (c) **SWEEP SINGLE.**
- (29) Change synthesized signal generator No. 1 output frequency to 4.0719 GHz.
- (30) Press TI keys as listed in (a) and (b) below:
- (a) **SWEEP SINGLE.**
 - (b) **MARKER PEAK SEARCH.**
- (31) The marker Δ amplitude indicated on TI display will be within limits specified in the first row of table 38.
- (32) Repeat technique of (29) through (31) above for remaining frequencies listed in table 38. The marker Δ amplitude indicated on TI display will be within limits specified table 38.

Table 38. Out of Band Response (9 GHz)

Synthesized signal generator No. 1	Test instrument
Frequency (GHz)	Displayed amplitude limit (dB)
4.0719	≤-60
4.6607	≤-60
8.3572	≤-70
12.6965	≤-60
13.3393	≤-60

- (33) Press TI keys as listed in (a) through (c) below:
- (a) **SWEEP CONT.**
 - (b) **MARKER OFF.**
 - (c) **CENTER FREQUENCY, 12, GHz.**
- (34) Set synthesized signal generator No. 1 output frequency to 12.0 GHz.
- (35) Press TI **MARKER PRESEL PEAK** key and wait for **(PEAKING!)** on TI to disappear.
- (36) Press TI **MARKER OFF** key.

(37) Adjust synthesized signal generator No. 1 output level to place the peak of the signal trace at the top TI graticule line.

(38) Press TI keys as listed in (a) through (c) below:

- (a) **MARKER PEAK SEARCH.**
- (b) **MARKER Δ.**
- (c) **SWEEP SINGLE.**

(39) Change synthesized signal generator No. 1 output frequency to 5.5179 GHz.

(40) Press TI keys as listed in (a) and (b) below:

- (a) **SWEEP SINGLE.**
- (b) **MARKER PEAK SEARCH.**

(41) The marker Δ amplitude indicated on TI display will be within limits specified in the first row of table 39.

(42) Repeat technique of (39) through (41) above for remaining frequencies listed in table 39. The marker Δ amplitude indicated on TI display will be within limits specified table 39.

Table 39. Out of Band Response (12 GHz)

Synthesized signal generator No. 1	Test instrument
Frequency (GHz)	Displayed amplitude limit (dB)
5.5179	≤-60
6.1607	≤-60
11.3572	≤-70
17.1965	≤-60
17.8393	≤-60

(43) Press TI keys as listed in (a) through (c) below:

- (a) **SWEEP CONT.**
- (b) **MARKER OFF.**
- (c) **CENTER FREQUENCY, 15, GHz.**

(44) Set synthesized signal generator No. 1 output frequency to 15.0 GHz.

(45) Press TI **MARKER PRESEL PEAK** key and wait for **(PEAKING!)** on TI to disappear.

(46) Press TI **MARKER OFF** key.

(47) Adjust synthesized signal generator No. 1 output level to place the peak of the signal trace at the top TI graticule line.

(48) Press TI keys as listed in (a) through (c) below:

- (a) **MARKER PEAK SEARCH.**
- (b) **MARKER Δ.**
- (c) **SWEEP SINGLE.**

(49) Change synthesized signal generator No. 1 output frequency to 4.5715 GHz.

(50) Press TI keys as listed in (a) and (b) below:

- (a) **SWEEP SINGLE.**

(b) **MARKER PEAK SEARCH.**

(51) The marker Δ amplitude indicated on TI display will be within limits specified in the first row of table 40.

(52) Repeat technique of (49) through (51) above for remaining frequencies listed in table 40. The marker Δ amplitude indicated on TI display will be within limits specified table 40.

Table 40. Out of Band Response (15 GHz)

Synthesized signal generator No. 1	Test instrument
Frequency (GHz)	Displayed amplitude limit (dB)
4.5715	≤ -60
5.2143	≤ -60
9.4643	≤ -60
10.1071	≤ -60
14.3572	≤ -70

(53) Press TI keys as listed in (a) through (c) below:

- (a) **SWEEP CONT.**
- (b) **MARKER OFF.**
- (c) **CENTER FREQUENCY, 17, GHz.**

(54) Set synthesized signal generator No. 1 output frequency to 17.0 GHz.

(55) Press TI **MARKER PRESEL PEAK** key and wait for **(PEAKING!)** on TI to disappear.

(56) Press TI **MARKER OFF** key.

(57) Adjust synthesized signal generator No. 1 output level to place the peak of the signal trace at the top TI graticule line.

(58) Press TI keys as listed in (a) through (c) below:

- (a) **MARKER PEAK SEARCH.**
- (b) **MARKER Δ .**
- (c) **SWEEP SINGLE.**

(59) Change synthesized signal generator No. 1 output frequency to 5.2381 GHz.

(60) Press TI keys as listed in (a) and (b) below:

- (a) **SWEEP SINGLE.**
- (b) **MARKER PEAK SEARCH.**

(61) The marker Δ amplitude indicated on TI display will be within limits specified in the first row of table 41.

(62) Repeat technique of (59) through (61) above for remaining frequencies listed in table 41. The marker Δ amplitude indicated on TI display will be within limits specified table 41.

Table 41. Out of Band Response (17 GHz)

Synthesized signal generator No. 1	Test instrument
Frequency (GHz)	Displayed amplitude limit (dB)
5.2381	≤-60
5.8809	≤-60
10.7977	≤-60
11.4405	≤-60
16.3572	≤-70

- (63) Press TI keys as listed in (a) through (d) below:
- SWEEP CONT.**
 - MARKER OFF.**
 - CENTER FREQUENCY, 5.7, GHz.**
 - REFERENCE LEVEL, 0 dBm.**
- (64) Set synthesized signal generator No. 1 output frequency to 5.7 GHz.
- (65) Press TI **MARKER PRESEL PEAK** key and wait for **(PEAKING!)** on TI to disappear.
- (66) Press TI keys as listed in (a) through (d) below:
- MARKER PEAK SEARCH.**
 - MARKER MKR CF.**
 - MARKER OFF.**
 - FREQUENCY SPAN, 5, kHz.**
- (67) Adjust synthesized signal generator No. 1 output level to place the peak of the signal trace at the top TI graticule line.
- (68) Press TI keys as listed in (a) through (g) below:
- MARKER NORMAL.**
 - MARKER PEAK SEARCH.**
 - MARKER Δ.**
 - SWEEP CONT.**
 - CENTER FREQUENCY, 2.3679, GHz.**
 - SWEEP SINGLE.**
 - SHIFT, SWEEP CONT.**
- (69) When sweep is completed press TI **SWEEP SINGLE** key and wait for the sweep to finish.
- (70) Press TI **MARKER PEAK SEARCH** key.
- (71) The marker Δ amplitude indicated on TI display will be within limits specified in the first row of table 42.
- (72) Press TI keys as listed in (a) and (b) below:
- SHIFT.**
 - MARKER MKR/Δ→STP SIZE.**

(73) Repeat the technique used in (63) through (72) above using remaining TI and synthesized signal generator No. 1 settings in table 42. The marker Δ amplitudes indicated on TI display will be within limits specified in table 42.

Table 42. Multiple Responses

Synthesized signal generator No. 1	Test instrument		
	Initial center frequency setting (GHz)	Measure center frequency setting (GHz)	Displayed amplitude limit (dB)
5.7	5.7	2.3679	≤ -70
6.0	6.0	1.1893	≤ -50
12.0	12.0	8.107133	≤ -70
12.0	12.0	8.535667	≤ -70

(74) Press TI keys as listed in (a) through (f) below:

- (a) **SWEEP CONT.**
- (b) **MARKER NORMAL.**
- (c) **MARKER OFF.**
- (d) **FREQUENCY SPAN, 100, kHz.**
- (e) **CENTER FREQUENCY, 13, GHz.**
- (f) **REFERENCE LEVEL, 0, dBm.**

(75) Set synthesized signal generator No. 1 output frequency to 13.0 GHz.

(76) Press TI **MARKER PRESEL PEAK** key and wait for **(PEAKING!)** on TI to disappear.

(77) Press TI keys as listed in (a) through (d) below:

- (a) **MARKER MKR CF.**
- (b) **MARKER NORMAL.**
- (c) **MARKER OFF.**
- (d) **FREQUENCY SPAN, 5, kHz.**

(78) Adjust synthesized signal generator No. 1 output level to place the peak of the signal trace at the top TI graticule line.

(79) Press TI keys as listed in (a) through (g) below:

- (a) **MARKER NORMAL.**
- (b) **MARKER PEAK SEARCH.**
- (c) **MARKER Δ .**
- (d) **SWEEP CONT.**
- (e) **CENTER FREQUENCY, 1.0679, GHz.**
- (f) **SHIFT, SWEEP CONT.**
- (g) **SWEEP SINGLE.**

(80) When sweep is completed press TI **SWEEP SINGLE** key and wait for the sweep to finish.

(81) Press TI **MARKER PEAK SEARCH** key.

(82) The marker Δ amplitude indicated on TI display will be within limits specified in the first row of table 43.

(83) Repeat the technique used in (79) (d) through (g) and (80) through (82) above using remaining TI and synthesized signal generator No. 1 settings in table 43. The marker Δ amplitudes indicated on TI display will be within limits specified in table 43.

Table 43. Multiple Responses

Synthesized signal generator No. 1	Test instrument	
Frequency (GHz)	Center frequency setting (GHz)	Displayed amplitude limit (dB)
13.0	1.0679	≤ -45
13.0	1.91907	≤ -45
13.0	0.53395	≤ -45

- (84) Press TI keys as listed in (a) through (g) below:
- SHIFT, MARKER MKR/ Δ →STP SIZE.**
 - SWEEP CONT.**
 - MARKER NORMAL.**
 - MARKER OFF.**
 - FREQUENCY SPAN, 100, kHz.**
 - CENTER FREQUENCY, 15, GHz.**
 - REFERENCE LEVEL, 0, dBm.**
- (85) Set synthesized signal generator No. 1 output frequency to 15.0 GHz.
- (86) Press TI **MARKER PRESEL PEAK** key and wait for (**PEAKING!**) on TI to disappear.
- (87) Press TI keys as listed in (a) through (d) below:
- MARKER MKR CF.**
 - MARKER NORMAL.**
 - MARKER OFF.**
 - FREQUENCY SPAN, 5, kHz.**
- (88) Adjust synthesized signal generator No. 1 output level to place the peak of the signal trace at the top TI graticule line.
- (89) Press TI keys as listed in (a) through (g) below:
- MARKER NORMAL.**
 - MARKER PEAK SEARCH.**
 - MARKER Δ .**
 - SWEEP CONT.**
 - CENTER FREQUENCY, 10.107133, GHz.**
 - SHIFT, SWEEP CONT.**
 - SWEEP SINGLE.**
- (90) When sweep is completed press TI **SWEEP SINGLE** key and wait for the sweep to finish.
- (91) Press TI **MARKER PEAK SEARCH** key.
- (92) The marker Δ amplitude indicated on TI display will be within limits specified in table 44.

(93) Repeat the technique used in (89) (d) through (g) and (90) through (92) above using remaining TI and synthesized signal generator No. 1 settings in table 44. The marker Δ amplitudes indicated on TI display will be within limits specified in table 44.

Table 44. Multiple Responses

Synthesized signal generator No. 1	Test instrument	
Frequency (GHz)	Center freq. setting (GHz)	Displayed amplitude limit (dB)
15.0	10.107133	≤ -60
15.0	10.535667	≤ -60

b. Adjustments. None.

24. Gain Compression

a. Performance Check

- (1) Press TI keys as listed in (a) through (e) below:
 - (a) **2-22 GHz.**
 - (b) **SHIFT.**
 - (c) **ATTEN.**
 - (d) **SHIFT.**
 - (e) **0-2.5 GHz, 0, dBm.**
- (2) Connect measuring receiver sensor module to measuring receiver power reference output.
- (3) Zero and calibrate the sensor module.
- (4) Connect equipment as shown in figure 30.
- (5) Set synthesized signal generator No. 1 output frequency to 2.0 GHz and an output level of -14 dBm.
- (6) Press TI keys as listed in (a) through (c) below:
 - (a) **CENTER FREQUENCY, 2, GHz.**
 - (b) **FREQUENCY SPAN, 0, Hz.**
 - (c) **ATTEN, 0, dBm.**
- (7) Set up measuring receiver to measure RF power.
- (8) Adjust synthesized signal generator No. 1 output level for a -20.00 ± 0.05 dBm indication on measuring receiver.
- (9) Press TI keys as listed in (a) through (f) below:
 - (a) **REFERENCE LEVEL, 10, -dBm.**
 - (b) **VIDEO BW, 30, Hz.**
 - (c) **SCALE LIN.**
 - (d) **SHIFT.**
 - (e) **AUTO^A.**
 - (f) **MARKER NORMAL.**

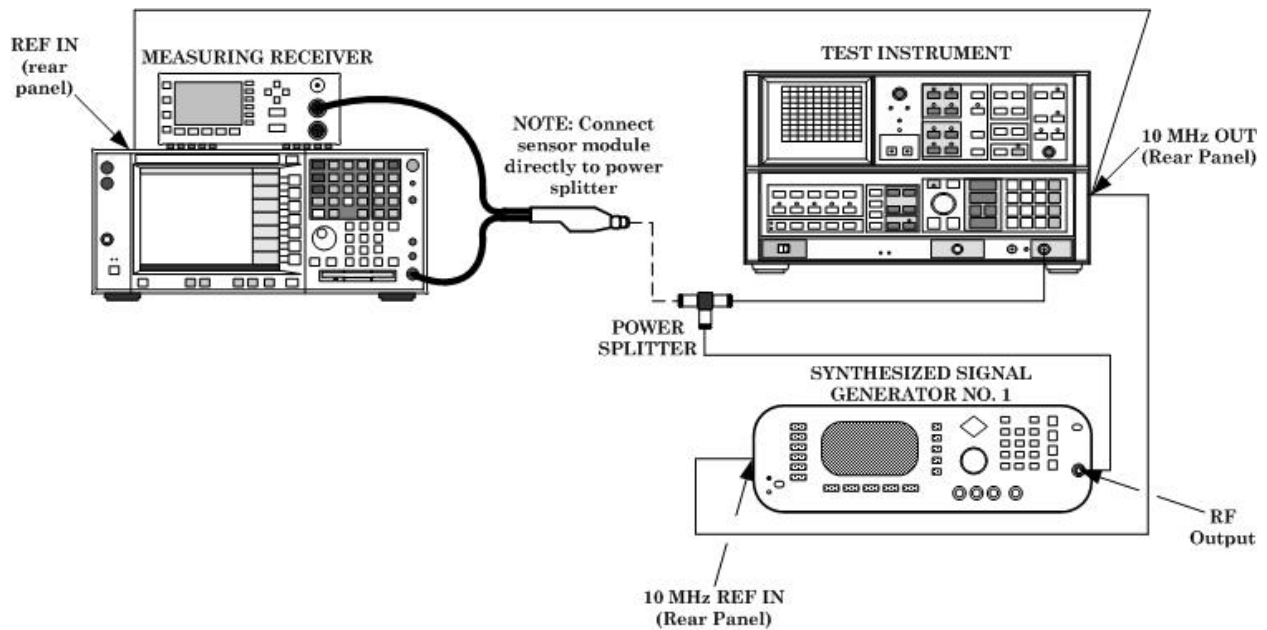

Figure 30. Third order intercept.

- (10) The marker amplitude indicated on TI display should be > -30 dBm.
- (11) Press TI **MARKER Δ** key.
- (12) Change synthesized signal generator No. 1 output level to -4 dBm.
- (13) Adjust synthesized signal generator No. 1 output level for a -10.00 ± 0.02 dBm indication on measuring receiver.
- (14) Press TI **REFERENCE LEVEL, 0,** and **dBm** keys.
- (15) Record the marker Δ amplitude indicated on TI display in displayed amplitude column of table 45.

Table 45. Gain Compression (-10 dBm)

Measuring receiver indication	Test instrument	
	Reference level (dBm)	Displayed amplitude (dB)
-10	0	

- (16) Press TI **REFERENCE LEVEL, 10,** and **-dBm** keys.
- (17) Adjust TI **AMPLITUDE CAL** control to place the signal trace 1 division below the top graticule.
- (18) Press TI **MARKER NORMAL** and **Δ** keys.
- (19) Change synthesized signal generator No. 1 output level to 6 dBm.
- (20) Adjust synthesized signal generator No. 1 output level for a 0.00 ± 0.02 dBm indication on measuring receiver.
- (21) Press TI **REFERENCE LEVEL, 0,** and **dBm** keys.

(22) Record the marker amplitude indicated on TI display in displayed amplitude column of table 46.

Table 46. Gain Compression (0 dBm)

Measuring receiver indication	Test instrument	
Level (dBm)	Reference level (dBm)	Displayed amplitude (dB)
0	0	

(23) Calculate gain compression using the formula below. Calculated value will be within the limits specified in table 47.

$$\text{Amplitude @ 0 dBm} - \text{amplitude @ -10 dBm} = \text{gain compression}$$

$$(\text{Table 46 value}) - (\text{Table 45 value}) = \text{gain compression}$$

Table 47. Gain Compression (-10 to 0 dBm)

Calculated gain compression (dB)	
Min	Max
-1	1

(24) Press TI keys as listed in (a) through (c) below:

- (a) **2-22 GHz.**
- (b) **SHIFT, ATTEN.**
- (c) **SHIFT, 0-2.5 GHz, 0, dBm.**

(25) Set synthesized signal generator No. 1 output frequency to 3.0 GHz and an output level of -19 dBm.

(26) Press TI keys as listed in (a) through (c) below:

- (a) **CENTER FREQUENCY, 3, GHz.**
- (b) **FREQUENCY SPAN, 1, MHz.**
- (c) **ATTEN, 0, dBm.**

(27) Set up measuring receiver to measure tuned RF level and manually enter carrier frequency.

(28) Adjust synthesized signal generator No. 1 output level for a -25.00 ±0.05 dBm indication on measuring receiver.

(29) Press TI **MARKER PRESEL PEAK** key and wait for **(PEAKING!)** on TI to disappear.

(30) Press TI keys as listed in (a) through (h) below:

- (a) **SCALE LIN.**
- (b) **SHIFT.**
- (c) **AUTO^A.**
- (d) **REFERENCE LEVEL, 15, -dBm.**
- (e) **FREQUENCY SPAN, 0, Hz.**
- (f) **VIDEO BW, 30, Hz.**
- (g) **RES BW, 300, kHz.**
- (h) **MARKER NORMAL.**

(31) The marker amplitude indicated on TI display should be > -50 dBm.

- (32) Press TI **MARKER Δ** key.
- (33) Change synthesized signal generator No. 1 output level to -9 dBm.
- (34) Adjust synthesized signal generator No. 1 output level for a -15.00 ± 0.02 dBm indication on measuring receiver.
- (35) Press TI **REFERENCE LEVEL, 5, and -dBm**.
- (36) Record the marker Δ amplitude indicated on TI display in displayed amplitude column of table 48.

Table 48. Gain Compression (-15 dBm)

Measuring receiver indication	Test instrument	
Level (dBm)	Reference level (dBm)	Displayed amplitude (dBm)
-15	-5	

- (37) Press TI **REFERENCE LEVEL, 15, and -dBm** keys.
- (38) Adjust TI **AMPLITUDE CAL** control to place the signal trace 1 division below the top graticule.
- (39) Press TI **MARKER NORMAL** and Δ keys.
- (40) Change synthesized signal generator No. 1 output level to 1 dBm.
- (41) Adjust synthesized signal generator No. 1 output level for a -5.00 ± 0.02 dBm indication on measuring receiver.
- (42) Press TI **REFERENCE LEVEL, 5, and -dBm**.
- (43) Record the marker amplitude indicated on TI display in Displayed Amplitude column of table 49.

Table 49. Gain Compression (-5 dBm)

Measuring receiver indication	Test instrument	
Level (dBm)	Reference level (dBm)	Displayed amplitude (dBm)
-5	-5	

- (44) Calculate gain compression using the formula below. Calculated value will be within the limits specified in table 50.

$$\begin{aligned} &\text{Amplitude @ } -5 \text{ dBm} - \text{amplitude @ } -15 \text{ dBm} = \text{gain compression} \\ &(\text{Table 49 value}) - (\text{Table 48 value}) = \text{gain compression} \end{aligned}$$

Table 50. Gain Compression (-5 to -15 dBm)

Calculated gain compression (dBm)	
Min	Max
-1	1

- (45) Press TI keys as listed in (a) through (h) below:
 - (a) **RES BW, 3, MHz.**
 - (b) **VIDEO BW, 3, MHz.**

- (c) **REFERENCE LEVEL, 0, dBm.**
- (d) **SCALE LOG ENTER db/DIV, SHIFT, 10, -dBm.**
- (e) **SHIFT, ATTEN, SHIFT, 0-2.5 GHz, 0, dBm.**
- (f) **RES BW, 10, kHz.**
- (g) **VIDEO BW, 30, kHz.**
- (h) **SWEEP TIME, 30, mSEC.**

(46) Set synthesized signal generator No. 1 output frequency to 9.0 GHz and an output level of -9 dBm.

(47) Press TI keys as listed in (a) through (c) below:

- (a) **CENTER FREQUENCY, 9, GHz.**
- (b) **FREQUENCY SPAN, 1, MHz.**
- (c) **ATTEN, 0, dBm.**

(48) Set up measuring receiver to measure RF power.

(49) Adjust synthesized signal generator No. 1 output level for a -15.00 ±0.05 dBm indication on measuring receiver.

(50) Press TI **MARKER PRESEL PEAK** key and wait for **(PEAKING!)** on TI to disappear.

(51) Press TI keys as listed in (a) through (f) below:

- (a) **SCALE LIN.**
- (b) **SHIFT, AUTO^A.**
- (c) **REFERENCE LEVEL, 15, -dBm.**
- (d) **FREQUENCY SPAN, 0, Hz.**
- (e) **VIDEO BW, 30, Hz.**
- (f) **MARKER NORMAL.**

(52) The marker amplitude indicated on TI display should be > -50 dBm.

(53) Press TI **MARKER Δ** key.

(54) Change synthesized signal generator No. 1 output level to 1 dBm.

(55) Adjust synthesized signal generator No. 1 output level for a -5.00 ±0.02 dBm indication on measuring receiver.

(56) Press TI **REFERENCE LEVEL, 5,** and **-dBm** keys.

(57) Record the marker amplitude indicated on TI display in displayed amplitude column of table 51.

Table 51. Gain Compression (-5 dBm)

Measuring receiver indication	Test instrument	
	Reference level (dBm)	Displayed amplitude (dBm)
-5	-5	

(58) Calculate gain compression using the formula below. Calculated value will be within the limits specified in table 52.

$$\begin{aligned} \text{Amplitude @ -15 dBm} - \text{amplitude @ -5 dBm} &= \text{gain compression} \\ (\text{Table 48 value}) - (\text{Table 51 value}) &= \text{gain compression} \end{aligned}$$

Table 52. Gain Compression (-5 to -15 dBm)

Calculated gain compression (dBm)	
Min	Max
-1	1

(59) Disconnect power splitter from TI **RF INPUT**.

(60) Connect TI **RF INPUT** to TI **CAL OUTPUT**.

(61) Press TI keys as listed in (a) and (b) below:

(a) **RECALL, 8.**

(b) **MARKER PEAK SEARCH.**

(62) Adjust TI **AMPTD CAL** for a marker amplitude of -10.00 ± 0.02 dBm as indicated on the TI display.

b. Adjustments. None.

25. First LO Output Amplitude Accuracy

a. Performance Check

(1) Connect measuring receiver sensor module to measuring receiver power reference output.

(2) Zero and calibrate the sensor module.

(3) Disconnect measuring receiver sensor module from measuring receiver power reference output.

(4) Press TI keys as listed in (a) through (d) below:

(a) **2-22 GHz.**

(b) **START FREQ, 2.3, GHz.**

(c) **STOP FREQ, 6.0, GHz.**

(d) **SWEEP SINGLE.**

(5) Remove termination from TI **1st LO OUTPUT**.

(6) Connect measuring receiver sensor module to TI **1st LO OUTPUT**.

(7) Set up measuring receiver to measure RF power.

(8) Press TI **SWEEP TIME, 100**, and **SEC** keys.

(9) Press TI **SWEEP SINGLE** key and observe measuring receiver indications as TI sweeps from 2.3 to 6.0 GHz. The measuring receiver indication should be $>+5$ dBm across the full sweep.

(10) Disconnect measuring receiver sensor module from TI **1st LO OUTPUT**.

(11) Reinstall termination to TI **1st LO OUTPUT**.

b. Adjustments. None.

26. Sweep and Tune Out Accuracy

a. Performance Check

(1) Connect TI **SWEEP + TUNE OUT** (rear panel) to multimeter **INPUT**.

- (2) Set up multimeter to measure V dc.
- (3) Press TI keys as listed in (a) through (c) below:
 - (a) **2-22 GHz.**
 - (b) **FREQUENCY SPAN, 0, Hz.**
 - (c) **CENTER FREQUENCY, 0, Hz.**
- (4) The reading indicated on multimeter will be within limits specified in the first row of table 53.
- (5) Repeat technique of (3) (c) and (4) above for remaining frequencies listed in table 53.

Table 53. Sweep and Tune Out

Test instrument	Multimeter Indication (Vdc)	
	Min	Max
Frequency		
0 Hz	-0.01	0.01
1 MHz	-0.11	0.009
12 MHz	-0.022	-0.002
130 MHz	-0.143	-0.117
670 MHz	-0.693	-0.647
1.3 GHz	-1.336	-1.264
5.7 GHz	-5.824	-5.576
12.5 GHz	-12.76	-12.24
18 GHz	-18.37	-17.63

- (6) Disconnect TI **SWEEP + TUNE OUT** (rear panel) from multimeter **INPUT**.
- b. Adjustments.** None.

27. Fast Sweep Time Accuracy

a. Performance Check

- (1) Connect TI **RF INPUT** to signal generator RF output connector.
- (2) Connect function generator **UNBALANCED** output to signal generator amplitude modulation input connector.
- (3) Press TI **2-22 GHz** key.
- (4) Set signal generator for an output frequency of 500 MHz and an output level of -10 dBm.
- (5) Press TI keys as listed in (a) through (e) below:
 - (a) **CENTER FREQUENCY, 500, MHz.**
 - (b) **FREQUENCY SPAN, 100, kHz.**
 - (c) **MARKER NORMAL.**
 - (d) **MARKER PEAK SEARCH.**
 - (e) **MARKER→CF.**
- (6) Set function generator for a triangle wave output at a frequency of 2 kHz, an amplitude of 1 V, and 50 Ω impedance.

- (7) Set signal generator for an 80 percent amplitude modulation output.
- (8) Press TI keys as listed in (a) through (f) below:
 - (a) **MARKER OFF.**
 - (b) **FREQUENCY SPAN, 0, Hz.**
 - (c) **RES BW, 3, MHz.**
 - (d) **VIDEO BW, 3, MHz.**
 - (e) **TRIGGER VIDEO.**
 - (f) **SWEEP TIME, 5, mSEC.**
- (9) Adjust TI **TRIGGER LEVEL** control to place a peak of the triangular waveform on the first graticule from the left edge of the TI crt display as a reference.
- (10) The fifth peak from the reference will be within the limits in the first row of table 54 from the sixth graticule from the left edge of the TI crt display.
- (11) Repeat the technique used in (6), (8) (f), (9) and (10) above for remaining TI sweep times and function generator frequencies in table 54. The fifth peak from the reference will be within the limits outlined in table 54.

Table 54. Fast Sweep Time

Function generator	Test instrument	
	Sweep time	Sweep time error (divisions)
2.00	5 ms	±0.5
5.00	2 ms	±0.5
10.00	1 ms	±0.5
50.0	200 μs	±0.5
100.0	100 μs	±0.5

- (12) Disconnect TI **RF INPUT** from signal generator RF output connector.
- (13) Disconnect function generator **UNBALANCED** output from signal generator amplitude modulation input connector.

b. Adjustments. None.

28. Power Supply

NOTE

Do not perform power supply adjustments if all other parameters are within tolerance.

a. Performance Check

- (1) Set TI **LINE** switch to **STANDBY**.
- (2) Remove TI top cover.
- (3) Set **LINE** switch to **ON**.
- (4) Indicator A1A8DS1 MAINS (fig. 31) (red LED) should be lit.

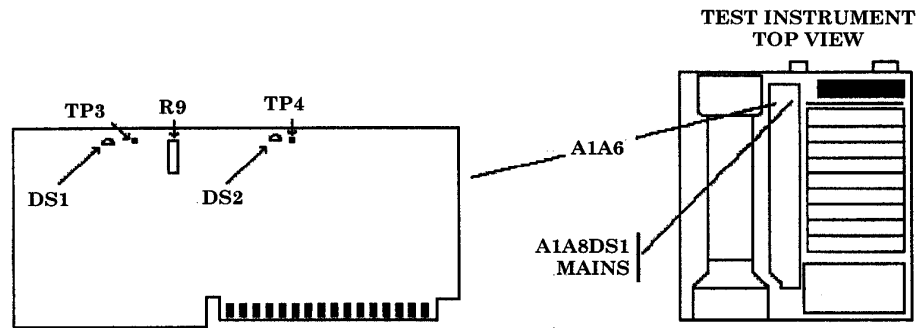

Figure 31. A1A6 board.

- (5) Connect multimeter **HI** to A1A6TP3 (fig. 31) and multimeter **LO** to TI chassis.
- (6) The +15 V indicator A1A6DS1 (fig. 31) (yellow LED) should be lit.
- (7) Adjust A1A6R9 (fig. 31) for a multimeter indication of 15.000 ± 0.010 V dc (R).
- (8) Connect multimeter **HI** to A1A6TP4 (fig. 31) and multimeter **LO** to TI chassis.
- (9) The -15V indicator A1A6DS2 (fig. 31) (yellow LED) should be lit.
- (10) Multimeter should indicate -15.000 ± 0.050 V dc.
- (11) Connect multimeter **HI** to A1A7TP3 (fig. 32) and multimeter **LO** to TI chassis.

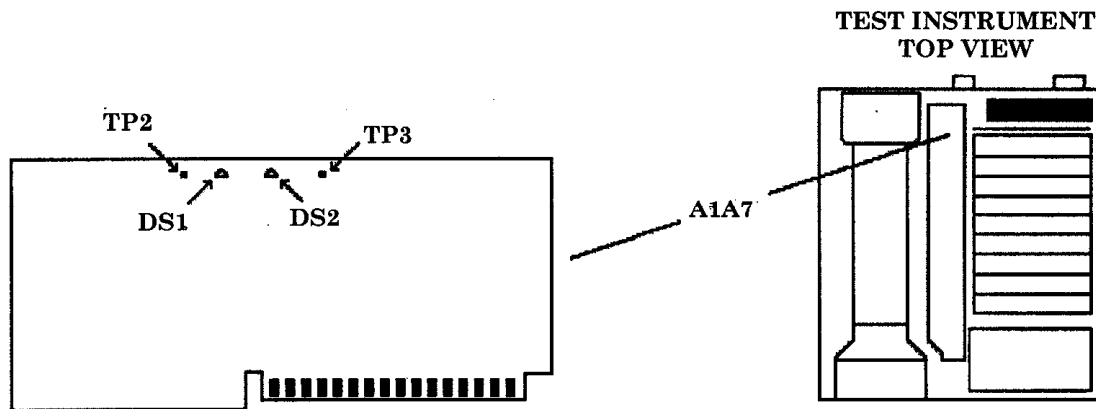

Figure 32. A1A7 Board

- (12) The 120 V indicator A1A7DS1 (fig. 32) should be lit.
- (13) Multimeter should indicate 120.0 ± 2.0 Vdc.
- (14) Connect multimeter **HI** to A1A7TP2 (fig. 32) and multimeter **LO** to TI chassis.
- (15) The 5.2 V indicator A1A7DS1 (fig. 32) (yellow LED) should be lit.
- (16) Multimeter should indicate 5.200 ± 0.050 V dc.

- (17) Disconnect multimeter from TI.
- (18) Position TI on its right side.
- (19) Remove TI bottom cover.
- (20) Connect multimeter **HI** to A8TP1 (fig. 33) and multimeter **LO** to TI chassis.

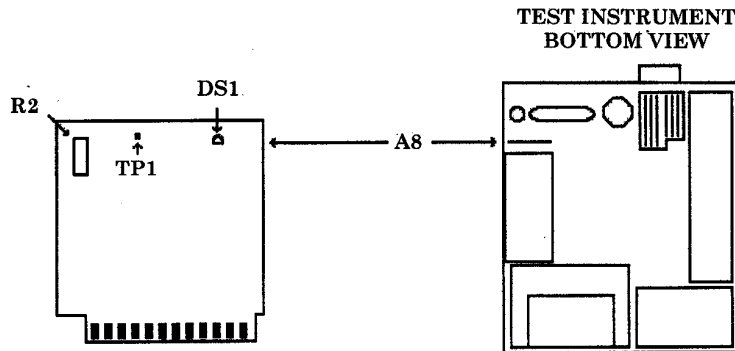

Figure 33. A8 board.

- (21) The 22 V indicator A8DS1 (fig. 33) (yellow LED) should be lit.
- (22) Adjust A8R2 (fig. 33) for a multimeter indication of 22.000 ± 0.020 V dc (R).
- (23) Connect multimeter **HI** to A17TP4 (fig. 34) and multimeter **LO** to TI chassis.

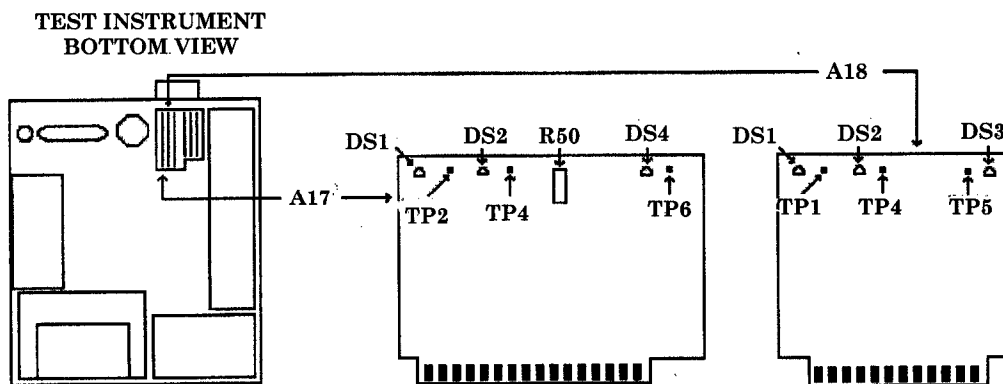

Figure 34. A17 & A18 boards.

- (24) The 20 V indicator A17DS2 (fig. 34) (yellow LED) should be lit.
- (25) Adjust A17R50 (fig. 34) for a multimeter indication of 20.000 ± 0.001 V dc (R).
- (26) Connect multimeter **HI** to A17TP6 (fig. 34) and multimeter **LO** to TI chassis.
- (27) The 12 V indicator A17DS4 (fig. 34) (yellow LED) should be lit.
- (28) Multimeter should indicate 12.25 ± 0.30 V dc.
- (29) Connect multimeter **HI** to A17TP2 (fig. 34) and multimeter **LO** to TI chassis.
- (30) The 5.2 V indicator A17DS1 (fig. 34) (yellow LED) should be lit.

TB 9-6625-2340-24

- (31) Multimeter should indicate 5.2 ± 0.05 V dc.
- (32) Connect multimeter **HI** to A18TP5 (fig. 34) and multimeter **LO** to TI chassis.
- (33) The -5.2 V indicator A18DS3 (fig. 34) (yellow LED) should be lit.
- (34) Multimeter should indicate -5.2 ± 0.05 V dc.
- (35) Connect multimeter **HI** to A18TP1 (fig. 34) and multimeter **LO** to TI chassis.
- (36) The -40 V indicator A18DS1 (fig. 34) (yellow LED) should be lit.
- (37) Multimeter should indicate -39.8 ± 0.4 V dc.
- (38) Connect multimeter **HI** to A18TP4 (fig. 34) and multimeter **LO** to TI chassis.
- (39) The -10 V indicator A18DS2 (fig. 34) (yellow LED) should be lit.
- (40) Multimeter should indicate -10.0 ± 0.1 V dc.

29. Final Procedure

- a. Deenergize and disconnect all equipment.
- b. Annotate and affix DA label/form in accordance with TB 750-25.

By Order of the Secretary of the Army:

Official:

GEORGE W. CASEY, JR.
General, United States Army
Chief of Staff

JOYCE E. MORROW
Administrative Assistant to the
Secretary of the Army

0719036

Distribution:

To be distributed in accordance with the initial distribution number (IDN) 344766, requirements for calibration procedure TB 9-6625-2340-24.

Instructions for Submitting an Electronic 2028

The following format must be used if submitting an electronic 2028. The subject line must be exactly the same and all fields must be included; however, only the following fields are mandatory: 1, 3, 4, 5, 6, 7, 8, 9, 10, 13, 15, 16, 17, and 27.

From: "Whomever" whomever@redstone.army.mil

To: <2028@redstone.army.mil

Subject: DA Form 2028

1. **From:** Joe Smith
2. **Unit:** home
3. **Address:** 4300 Park
4. **City:** Hometown
5. **St:** MO
6. **Zip:** 77777
7. **Date Sent:** 19-OCT-93
8. **Pub no:** 55-2840-229-23
9. **Pub Title:** TM
10. **Publication Date:** 04-JUL-85
11. **Change Number:** 7
12. **Submitter Rank:** MSG
13. **Submitter FName:** Joe
14. **Submitter MName:** T
15. **Submitter LName:** Smith
16. **Submitter Phone:** 123-123-1234
17. **Problem:** 1
18. **Page:** 2
19. **Paragraph:** 3
20. **Line:** 4
21. **NSN:** 5
22. **Reference:** 6
23. **Figure:** 7
24. **Table:** 8
25. **Item:** 9
26. **Total:** 123
27. **Text**

This is the text for the problem below line 27.

